

Mercury™ 3000 Smart Encoder Systems

Programmable Interpolation in Integer Steps to 0.020µm

Next Generation Ruggedized Design Replaces Mercury 3100

Reflective Linear and Rotary Encoder Systems

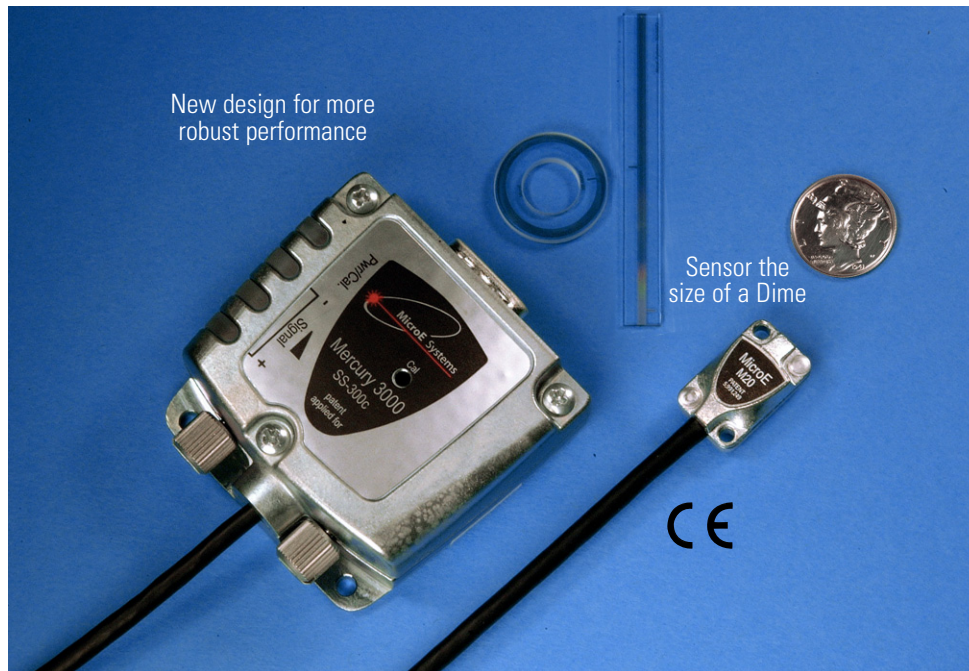

Resolution

Linear: 5µm to 0.020µm
Rotary: 6,600 to 16.8 M CPR

Accuracy

Linear: ± 1µm available
± 3µm to ± 5µm standard
Rotary: Up to ± 2.1 arc-sec

Output

A-quad-B and Index Pulse

The New Mercury 3000 encoder represents the next level of encoder performance. With programmable interpolation, smallest sensor size, easiest alignment, and superior noise immunity, the M3000 delivers Best-in-Class performance.

Imagine what you can do with this!

The new Mercury 3000 can reduce the cost and size of your system, and improve its performance all at once! MicroE Systems' Mercury 3000 kit encoders are smaller, higher performance, faster to install, and easier to set up and align than any other encoder. The tiny sensor fits into very tight spaces and works in both linear and rotary applications.

New features

- New metal enclosure for SmartPrecision™ electronics
- Best-in-Class noise immunity for harsh environments
- Shorter length for smaller, tighter cabinets
- Frame mounting compatible for easy installation
- Robust metal housing with easy access locking screws
- Double shielded long life cable
- CE compliant

Standard features

- Smallest sensor- 1/3 the size of other encoders
- Revolutionary bolt-in alignment for many applications
- Advanced SmartPrecision electronics built into shielded D-sub connector
- A-quad-B output with programmable interpolation in integer steps for resolutions to 0.020µm (linear); 16.8M CPR (rotary)
- LED set up indicators for sensor alignment and index location
- Bi-directional index signal is repeatable to encoder resolution

Table of Contents

System & Sensor	pg 1-5
SmartPrecision Electronics	pg 6-7
SmartPrecision Software	pg 8
Scales	pg 9-10
Ordering Information	pg 10

Optional features

- Glass scale length or diameter
- Linear lengths from 5mm to 2m
- Rotary diameters from 12mm to 108mm
- Cable length of 0.5m, 1m, 2m, or custom
- SmartPrecision Software



System Configurations

Standard and Optional Equipment

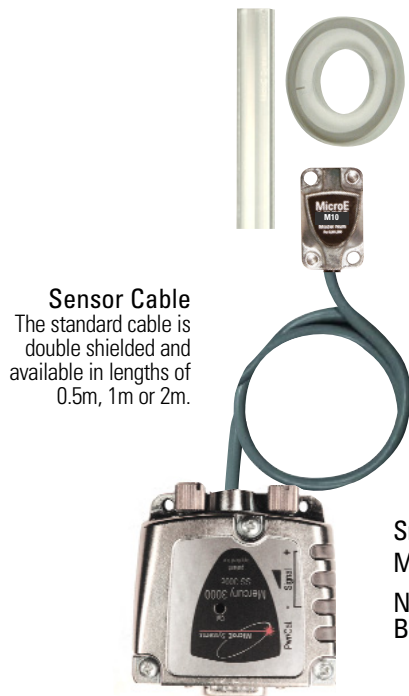

Sensor Cable
The standard cable is double shielded and available in lengths of 0.5m, 1m or 2m.

Encoder Sensor
Same for linear and rotary scales.

SmartPrecision™ Electronics Module

New Metal Enclosure Provides Best-in-Class Noise Immunity

A 15 pin high density D-sub connector mates to the customer controller.

M3000 Smart Encoder Systems Standard Equipment



RS 232 Interface Adapter

The adapter provides connections to a PC, the encoder system and the controller.

M3000 Optional Equipment



SmartPrecision™ Software

The software module enables all programmable and diagnostic features plus displays encoder output and signal strength. See page 8 for details.

Broader Alignment Tolerances, Increased Standoff Clearance, Smallest Sensor and More

Why Mercury Encoders Make It Easier To Design High Performance Into Your Equipment

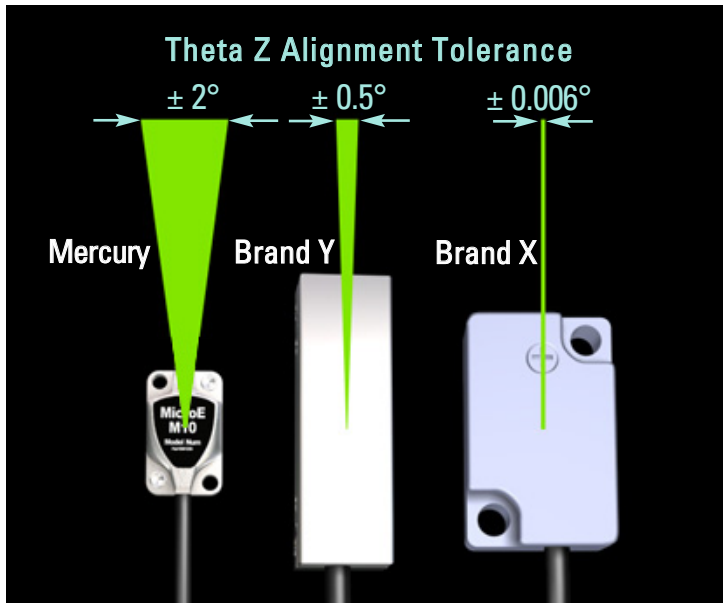

Eliminate the Frustration of Touchy Encoder Alignment

Mercury Solves this Problem for Good

Fussy alignment is no longer a concern. With Mercury's patented PurePrecision™ optics, advanced SmartPrecision™ electronics and LED alignment indicators, you can push the sensor against your reference surface, tighten the screws and you're finished. Try that with brand X or Y.

This performance is possible thanks to relaxed alignment tolerances, particularly in the theta Z axis. Mercury offers a ± 2° sweet spot— that's a 300% improvement over the best competitive encoder. And that will result in dramatic savings in manufacturing costs.

No other commercially available encoder is easier to align, easier to use, or easier to integrate into your designs.

Alignment Tolerance Comparison**

	Mercury*	Brand X	Brand Y	Mercury vs. Best Competitor
Z Standoff	± 0.15mm	± 0.1mm	± 0.1mm	Mercury is 50% better
Y	± 0.20mm for linear ± 0.10mm for rotary ≥19mm dia.	± 0.1mm	unspecified	Mercury is 100% better
theta X	± 1.0°	unspecified	± 1.0°	
theta Y	± 2.0°	± 0.1°	± 1.0°	Mercury is 100% better
theta Z	± 2.0°	± 0.006°	± 0.5°	Mercury is 300% better

*Measured at a constant temperature for one axis at a time with all other axes at their ideal positions.

**Based on published specifications

Mercury Can Reduce System Size and Cost

Mercury's sensor height is 44% shorter than competitive encoders, making it easy to fit into your design. This reduction can also cut total system weight and cost by allowing the use of smaller motors and stages. Safe system operation is also enhanced thanks to Mercury's generous standoff clearance— 200% greater than other encoders. And its standoff tolerance is 50% greater than the best alternative.

This significantly relaxes mechanical system tolerances, while reducing system costs.

Mechanical Dimension Comparison**

	Mercury	Brand X	Brand Y	Mercury vs. Best Competitor
Sensor Z height	8.4mm	23mm	15mm	44% better
Standoff clearance	2.4mm	0.5mm	0.8mm	200% better
Standoff tolerance	± 0.15mm	± 0.1mm	± 0.1mm	50% better
System height	11.7mm	28.5mm	15.8mm	26% better

**Based on published specifications

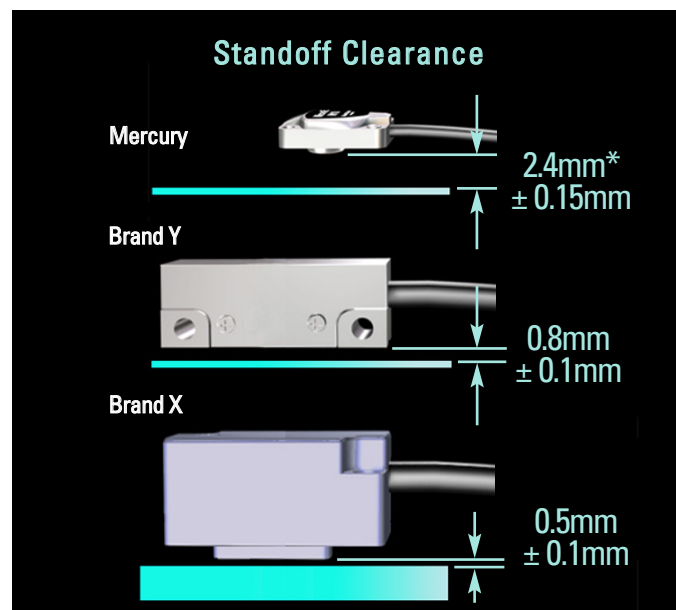

* Dimensions shown illustrate encoder system standoff clearance; see Mercury Encoder Interface Drawings for correct design reference surfaces.

System Specifications

Resolution and Maximum Speed

Mercury 3000 systems have programmable interpolation from x4 to x1024 in integer steps. Below is a table of sample values.

Linear - 20µm grating pitch

Interpolation	Resolution	Maximum Speed*
x4	5.000µm/count	7200mm/s
x10	2.000µm/count	7200mm/s
x20	1.000µm/count	7200mm/s
x40	0.500µm/count	7200mm/s
x80	0.250µm/count	7200mm/s
x100	0.200µm/count	5760mm/s
x200	0.100µm/count	2880mm/s
x400	0.050µm/count	1440mm/s
x1000	0.020µm/count	576mm/s

To calculate desired linear interpolation multiplier, use the following equation
 $Interpolation\ Multiplier = Grating\ Period\ (20\mu m) / Desired\ Resolution\ (\mu m/count)$

Rotary - 20µm grating pitch

Rotary Glass Scale Diameter	Fundamental Resolution	Interpolation				
		Note: The range of available values is x4 to x1024 in integer steps; example values below.				
0.472" [12.00mm]	1650 CPR	x4	x100	x256	x1024	
		interpolated resolution (CPR)	6,600	165,000	422,400	1,689,600
		interpolated resolution (arc-sec/count)**	196.4	7.85	3.08	0.767
		interpolated resolution (µrad/count)**	952	38.0	14.86	3.79
		maximum speed* (RPM)	13090	10470	4090	1020
0.750" [19.05mm]	2500 CPR	x4	x100	x256	x1024	
		interpolated resolution (CPR)	10,000	250,000	640,000	2,560,000
		interpolated resolution (arc-sec/count)**	129.6	5.18	2.03	0.506
		interpolated resolution (µrad/count)**	628.3	25.1	9.8	2.5
		maximum speed* (RPM)	8640	6912	2700	675
1.250" [31.75mm]	4096 CPR	x4	x100	x256	x1024	
		interpolated resolution (CPR)	16,384	409,600	1,048,576	4,194,304
		interpolated resolution (arc-sec/count)**	79.1	3.16	1.24	0.309
		interpolated resolution (µrad/count)**	383.5	15.3	6.0	1.5
		maximum speed* (RPM)	5273	4219	1648	412
2.250" [57.15mm]	8192 CPR	x4	x100	x256	x1024	
		interpolated resolution (CPR)	32,768	819,200	2,097,152	8,388,608
		interpolated resolution (arc-sec/count)**	39.6	1.58	0.618	0.154
		interpolated resolution (µrad/count)**	191.7	7.7	3.0	0.7
		maximum speed* (RPM)	2637	2109	824	206
4.250" [107.95mm]	16384 CPR	x4	x100	x256	x1024	
		interpolated resolution (CPR)	65,536	1,638,400	4,194,304	16,777,216
		interpolated resolution (arc-sec/count)**	19.7	0.791	0.309	0.0772
		interpolated resolution (µrad/count)**	95.9	3.83	1.5	0.4
		maximum speed* (RPM)	1318	1054	412	103

*Maximum speed produces an encoder quadrature output of up to 28.8 million states per second.

** Resolution values shown are approximate. To calculate exact resolution values, convert from CPR (Counts Per Revolution) to the desired units.

Note: Specifications assume XOR function which is available in all standard controllers.

To calculate desired rotary interpolation multiplier, use the following equation
 $Interpolation\ Multiplier = Desired\ Resolution\ (CPR) / Fundamental\ Scale\ Resolution\ (CPR)$

All Specifications are subject to change. All data is accurate to the best of our knowledge. MicroE Systems is not responsible for errors.

System Specifications

System

Grating Period	20µm
Signal Period	20µm
System Resolution	5µm - 0.020µm in integer interpolation steps (factory set or user programmed using MicroE SmartPrecision Software)

Linear accuracy*

Interpolation accuracy: Better than ± 0.12µm over any 20µm movement

Long-travel accuracy: ±1µm accuracy available - consult MicroE
 Better than ± 3µm for scales up to 130mm
 Better than ±5µm for scales 155mm to 1m
 Better than ±5µm per meter for scales 1m or more

*Maximum peak to peak error over the specified movement when compared to a NIST-traceable laser interferometer standard, used at room temperature and with MicroE interpolation electronics.

Rotary Accuracy*	Scale O.D.	Microradians	Arc-Seconds
	12.00mm	±100	±21
	19.05mm	±63	±13
	31.75mm	±38	±7.8
	57.15mm	±19	±3.9
	107.95mm	±10	±2.1

*Based on ideal scale mounting concentricity

Sensor Size

W:	12.70mm	0.500"
L:	20.57mm	0.810"
H:	8.38mm	0.330"

Operating and Electrical Specifications

Power Supply	5VDC ±5% @ 330mA (30mA for sensor)
Temperature	
Operating:	0 to 70°C
Storage:	-20 to 70°C
Humidity:	10 - 90% RH non-condensing
EMI:	CE Compliant
Shock:	1500G 0.5 ms half sine (Sensor)
Sensor Weight:	5.0g (Sensor without cable)
Cable:	Double Shield. Maximum length 2m. Diameter: 3.6mm (0.142") Flex Life: 20 x 10 ⁶ cycles @ 20mm bending radius

Mechanical Information - Sensor

19.7 [500] or 39.4 [1000]
or 78.7 [2000] ±.50 [12.7]

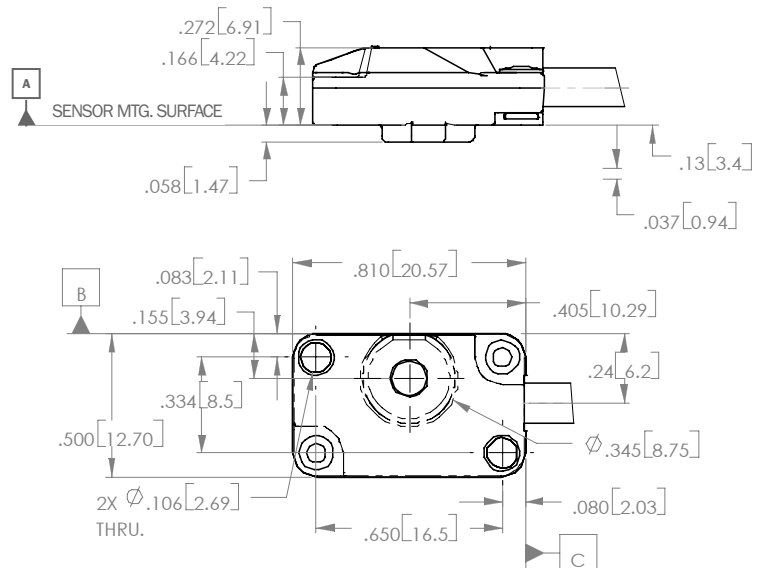
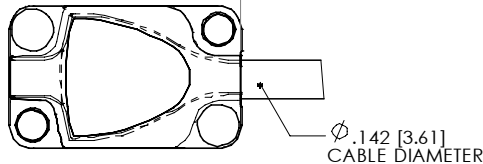

All Specifications are subject to change. All data is accurate to the best of our knowledge. MicroE Systems is not responsible for errors.

SmartPrecision™ Electronics Module

The Mercury 3000 encoder system includes a SmartPrecision electronics module. This compact, fully-featured signal processing system performs the following functions:

- Interpolation - up to 1024X with 28.8 million quadrature states / sec.
- Programmable interpolation level and output bandwidth
- Accuracy optimization - sensor signals are automatically optimized to improve system accuracy and maximize repeatability
- Signal strength indication - red / yellow / green LEDs assist during setup and provide diagnostics at a glance
- Index centering - centers the bi-directional index output pulse for repeatability to +/-1LSB
- Low Signal/Over Speed alarm
- Power-indicating LED
- Computer interface - for programming and data acquisition using SmartPrecision software
- Superior EMI / RFI immunity - CE compliant
- Mounting options - all electronics are within the EMI-shielded connector housing and can be screwed directly into a mating connector that is bulkhead mounted, or the module may be mounted to the frame of your motion system and connected using an extension cable

Programmable Interpolation

The electronics module has programmable interpolation that is selectable over the range x4 to x1024 in integer steps, providing output resolutions that can be matched to your application requirements. This feature provides linear resolutions from 5µm to 0.020µm in convenient increments (e.g. x200 interpolation = 0.1µm) and rotary resolutions from 6,600 CPR to 16.8M CPR. Specify the interpolation value at the time of ordering or select the interpolation at your site using SmartPrecision Software.

Programmable Maximum Output Frequency

For encoder applications combining high resolution and high speed, the SmartPrecision electronics module supports up to 28.8 million quadrature state changes per second**. By specifying the maximum output frequency to match your controller's capability - ranging from 900,000 up to 28.8 million quadrature state changes per second - the Mercury encoder system will never produce encoder counts faster than your controller can read them. Specify the encoder's maximum output frequency at the time of ordering or select the setting at your site using MicroE's SmartPrecision Software.

* The electronics module's serial computer programming interface can be translated to be RS-232 compatible using the MicroE SmartPrecision Computer Interface Adapter or a voltage translation circuit of your own design.

** "Quadrature state changes per second" is the reciprocal of "dwell time" or "edge separation". For example, 28.8 million states per second = 0.035µsec dwell time.

All Specifications are subject to change. All data is accurate to the best of our knowledge. MicroE Systems is not responsible for errors.



SmartPrecision module enclosure provides "Best-in-Class" noise immunity for high noise environments.

Mercury 3000 Outputs:

15-pin high density Male D-sub connector

PIN	FUNCTION
1	Reserved - Do not connect
2	Serial programming interface -transmit*
3	Serial programming interface -receive*
4	A- quadrature
5	A+ quadrature
6	Reserved - Do not connect
7	Reserved - Do not connect
8	Reserved - Do not connect
9	B- quadrature
10	B+ quadrature
11	Alarm
12	+5VDC
13	Ground
14	I+ index
15	I- index

Note: Contact MicroE for pin assignments and software protocols for the high speed serial output version.

Mechanical Information - electronics module

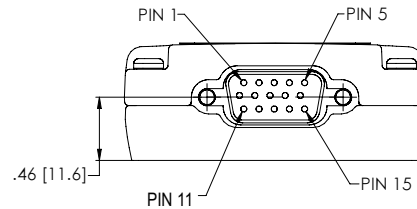
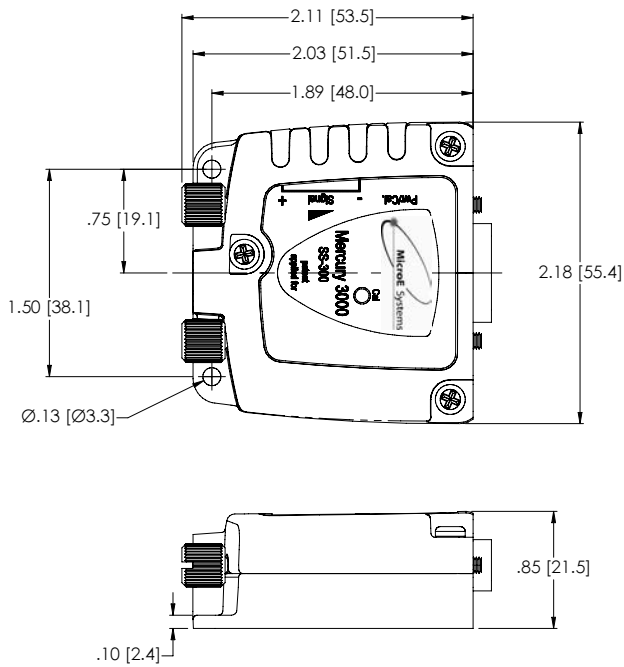

Male D-sub connector

Maximum Quadrature Output Frequency

Output Frequency	A-quad-B Output Rate	Dwell Time (or edge separation)
7.2MHz	28.8M quadrature states / sec	0.035 μ sec
3.6MHz	14.4M quadrature states / sec	0.069 μ sec
1.8MHz	7.2M quadrature states / sec	0.139 μ sec
900kHz	3.6M quadrature states / sec	0.278 μ sec
450kHz	1.8M quadrature states / sec	0.555 μ sec
225kHz	900k quadrature states / sec	1.111 μ sec

Output Signals

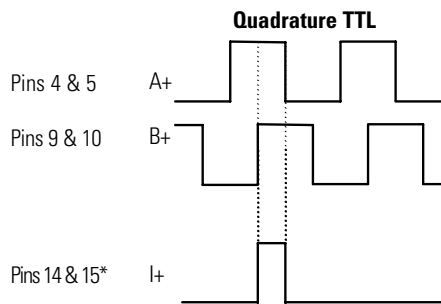

Signal Termination for A-Quad-B and Index

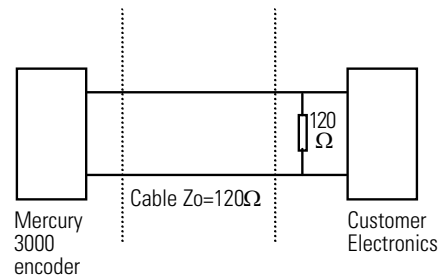

*Note: The index pulse may be aligned with A- or B- at some interpolation values.

SmartPrecision Software for Mercury 2000 and 3000 Encoder Systems

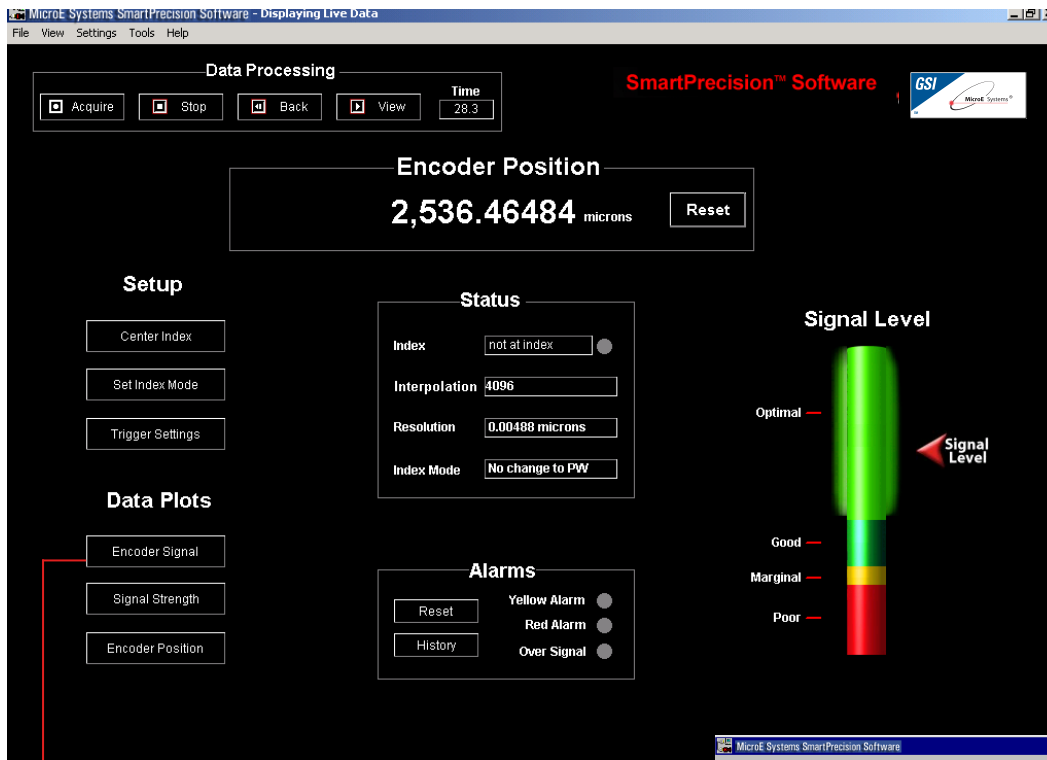

SmartPrecision Software makes Mercury the industry's easiest to use encoder. It helps you program, set up, use, and diagnose Mercury 2000 and 3000 encoders with the click of a mouse. Compatible with Windows 95, 98, ME, NT, 2000, and XP.

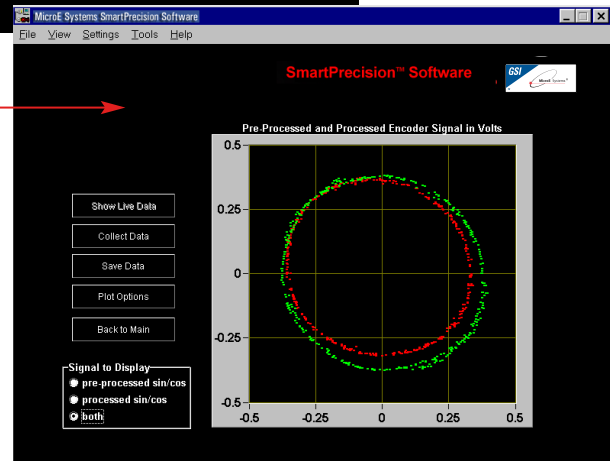

The encoder signal plot, or Lissajous plot, reveals the underlying strength and uniformity of the sensor's output.

Program Mercury Encoder Electronics

- Set interpolation in integer steps from x4 to x256 (Mercury 2000) or x4 to x1024 (Mercury 3000)
- Set maximum output frequency to match your controller

Install Mercury Encoder System

- Align sensor using Signal Level display and Encoder Signal data plot
- Locate index and see when sensor is over the scale's index mark
- Verify sensor output over length of scale using the Signal Strength plot

Monitor Mercury Encoder Operation

- Read encoder position in engineering units of your choice
- Read the encoder's hour meter to monitor system usage
- Capture alarms while system operates unattended

Diagnose Mercury Encoder Performance

- Capture signal data and email it to MicroE for rapid diagnostic support
- Monitor alarms, view the alarm history log

System Description

The SmartPrecision Software system includes Software on CD, a computer interface adapter, computer cable, and a power adapter.

How to Order SmartPrecision Software

To Purchase the SmartPrecision Software system, use this Model Number: SSWA120 for 120 VAC, 60Hz US Standard 2-prong plug or SSWA220 for 220 VAC, 50 Hz European Std. 2-prong plug

Scale Specifications

Standard and Customized Scales

MicroE Systems offers a wide array of chrome on glass scales for the highest accuracy and best thermal stability. Easy to install, standard linear and rotary scales meet most application requirements. Customized linear, rotary, and rotary segment scales are available where needed. All scales include an optical index. Mercury's glass scales save time by eliminating motion system calibrations or linearity corrections required by other encoders, and provide better thermal stability than metal tape scales.

Options include:

- *Standard linear*: 18mm - 2m
- *Standard rotary*: 12mm - 107.95mm diameter, with or without hubs
- *Custom linear**: special lengths, widths, thickness, index mark locations and special low CTE materials
- *Custom rotary**: special ID's, OD's (up to 304.8mm), index mark outside the main track and special low CTE materials
- *Mounting of hubs for rotary scales*: MicroE Systems can mount and align standard, custom, or customer-supplied hubs
- *Rotary segments**: any angle range; wide range of radius values

*Custom scales or rotary segments are available in OEM quantities. Contact your local MicroE Systems sales office.

Standard Short Linear Scales

130mm and Shorter

Key: inches[mm]

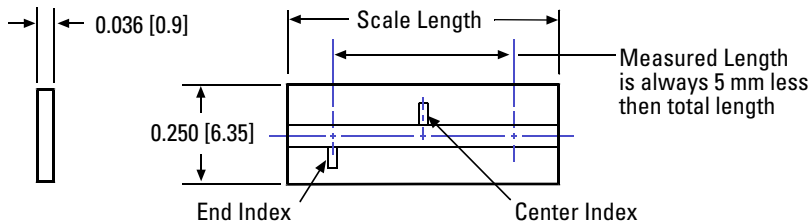

Specifications

Accuracy	±3µm standard ±1µm available
Material	Soda lime glass
Typical CTE	8ppm/°C
Index	Center or End

Model	L18	L30	L55	L80	L105	L130
Scale Length	0.709 [18]	1.181 [30]	2.165 [55]	3.150 [80]	4.134 [105]	5.118 [130]
Measured Length	0.512 [13]	0.984 [25]	1.969 [50]	2.953 [75]	3.937 [100]	4.921 [125]

Custom scales available

Standard Long Linear Scales

155mm and Longer

Key: inches[mm]

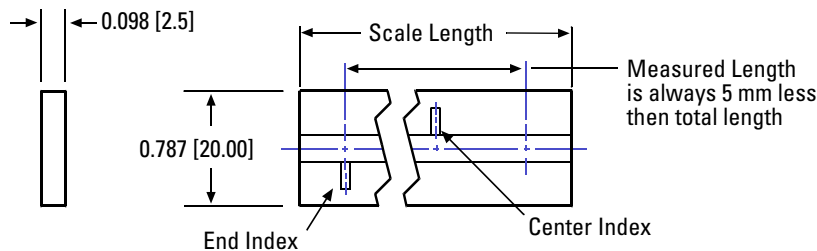

Specifications

Accuracy	±5 µm <1m ±5 µm/m >1m
Material	Soda lime glass
Typical CTE	8ppm/°C
Index	Center or End

Model	L155	L225	L325	L425	L525	L1025	L2025
Scale length	6.102 [155]	8.858 [225]	12.795 [325]	16.732 [425]	20.669 [525]	40.354 [1025]	79.724 [2025]
Measured length	5.906 [150]	8.661 [220]	12.598 [320]	16.535 [420]	20.472 [520]	40.157 [1020]	79.528 [2020]

Custom scales available

Standard Rotary Scales

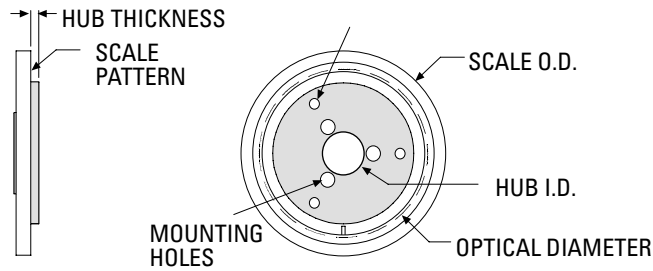

Specifications

Material	Soda lime glass
Typical CTE	8ppm/°C

Key: inches[mm]

Model No.	Scale Outer Diameter	Scale Inner Diameter	Optical Diameter	Hub Inner Diameter +0.0005/-0.0000	Hub Thickness	Fundamental CPR
R1206	0.472 [12.00]	0.250 [6.35]	0.413 [10.50]	0.1253 [3.18]	0.040 [1.02]	1650
R1910	0.750 [19.05]	0.375 [9.52]	0.627 [15.92]	0.1253 [3.183]	0.040 [1.02]	2500
R3213	1.250 [31.75]	0.500 [12.70]	1.027 [26.08]	0.2503 [6.358]	0.050 [1.27]	4096
R5725	2.250 [57.15]	1.000 [25.40]	2.053 [52.15]	0.5003 [12.708]	0.060 [1.52]	8192
R10851	4.250 [107.95]	2.000 [50.80]	4.106 [104.30]	1.0003 [25.408]	0.080 [2.03]	16384

Custom scales available

How to Order Mercury 3000 Encoder Systems

To specify your Mercury encoder with the desired scale, level of interpolation, maximum output frequency, cable length and software, consult the chart below to create the correct part number for your order. Call MicroE Systems' Rapid Customer Response team for more information [508] 903-5000.

Example (Linear Encoder): M3000-M10-1024-1-L55-C1

Example (Rotary Encoder): M3000-M10-1024-1-R1910-HA

<u>M3000</u>	-	<u>Cable Length</u>	-	<u>Interpolation</u>	-	<u>Maximum Output Frequency</u>	-	<u>Scale Model</u>	-	<u>Scale Mounting</u>
		M05 = 0.5 m M10 = 1.0 m M20 = 2.0 m		4 = 4x 5 = 5x 1024 = 1024x		1 = 7.2 MHz 2 = 3.6 MHz 3 = 1.8 MHz 4 = 900 kHz 5 = 450 kHz 6 = 225 kHz		Lxxx or Rxxxx		For linear scales: T = Tape mounting C1 = 3 scale clamps* C2 = 10 scale clamps** Hubs for Rotary Scales: NH = Without Hub HE = for R1206 HA = for R1910 HB = for R3213 HC = for R5725 HD = for R10851

How to Order SmartPrecision Software

SmartPrecision Software
 |
 SSWA120 for 120 VAC, 60Hz
 US Standard 2-prong plug
 or
 SSWA220 for 220 VAC,
 50 Hz European Std. 2-prong plug

* 3 clamps for linear scales up to 130mm
 ** 10 clamps for linear scales 155mm or longer

All Specifications are subject to change. All data is accurate to the best of our knowledge. MicroE Systems is not responsible for errors.

