

PLANETARY ROLLER SCREWS

ENDURANCE TECHNOLOGYSM
A Tolomatic Design Principle



LINEAR SOLUTIONS MADE EASY

Planetary Roller Screws

PLANETARY ROLLER SCREW OVERVIEW

Roller screws are designed to provide high force and efficient operation in a compact package. This unique design offers higher forces and longer life in a smaller package compared to ball screws, increasing a machine designer's ability to create compact machine concepts. Tolomatic roller screws are manufactured using state-of-the-art equipment to meet strict tolerances and the highest quality standards ensuring that each roller screw provides top-tier performance.

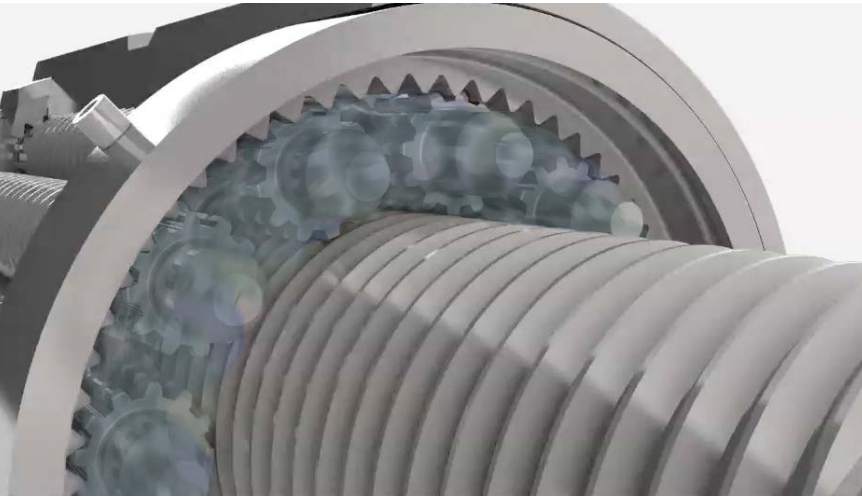

Tolomatic's Planetary Roller Screws:

- Verified and tested extensively in Tolomatic's research & development lab
- Proven long, reliable life in thousands of demanding applications world-wide through use in Tolomatic's RSH, IMA, RSA, RSX, TRS, ServoChoke, and ServoWeld actuator platforms.
- Configurable stroke lengths
- Option to machine screw ends to OEM specifications
- Industry best lead times

Available Configurations









SCREW SIZE	LEAD
mm	mm
15	4, 5, 10
20	4, 5, 10
30	5, 10
36	5, 10
39	10
48	12
63	10

See page 6 for complete list of screw sizes, lead availability, dimensions and specifications



tolomatic.com/ask
Technical support
before and after
purchase

Need a complete solution? Roller screws used in these Tolomatic products

	RSH	RSA	RSX	IMA	TRS	ServoChoke	CSWX
							
	Hygienic Rod-Style Actuator	Rod-Style Actuator	Rod-Style Actuator	Integrated Servo Actuator	Rodless Actuator	Integrated Servo Actuator	Integrated Servo Actuator
Force up to:	7,900 lbf (35.3 kN)	13,000 lbf (58.0 kN)	50,000 lbf (222.4 kN)	6,900 lbf (30.6 kN)	562 lbf (2.5 kN)	15,000 lbf (66.7 kN)	4,047 lbf (18.0 kN)
Speed up to:	20 in/sec (500 mm/sec)	123 in/sec (3,124 mm/sec)	30 in/sec (760 mm/sec)	53 in/sec (1,334 mm/sec)	36 in/sec (910 mm/sec)	0.77 in/sec (19.6 mm/sec)	27.6 in/sec (700 mm/sec)
Stroke Length up to:	48 in (1,200 mm)	60 in (1,520 mm)	35 in (890 mm)	18 in (460 mm)	43 in (1,090 mm)	3.75 in (95.3 mm)	6.3 in (160 mm)
Screw/ Nut Type	Ball & Roller	Solid, Ball & Roller	Roller	Ball & Roller	Ball & Roller	Roller	Roller
<i>For complete information see www.tolomatic.com or literature number:</i>							
Literature Number:	2100-4010	3600-4166	2171-4001	2700-4000	3600-4222	2600-4000	2750-4024

(Not all models deliver maximum values listed, i.e.: Maximum thrust may not be available with maximum speed)

Roller Screws vs. Ball Screws

Roller Screw



Capable of handling heavy loads, planetary roller screws contain precision ground rollers engaged with a precision ground screw. When compared with a ball screw of the same size and lead, the roller screw components are designed to have increased points of contact and a larger contact radius. This results in less stress per point of contact and allows roller screws to carry higher loads.

- Higher DLR = longer life
- Higher loads per given size
- Allows for smaller, lighter weight designs and machine concepts
- Compact design allows for flexibility in machine design
- Quiet, efficient operation

ROLLER AND BALL SCREW PERFORMANCE COMPARISONS

	ROLLER SCREW	BALL SCREW
Dynamic load rating	Very High	Medium
Lifetime	Very long life, many times greater than ball screw	Moderate
Shock Loads	Very high	Moderate
Relative Space Required	Minimal	Moderate
Acceleration	High	Moderate

Ball Screw

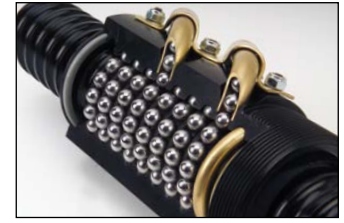

Capable of handling moderate loads, ball screw nut assemblies contain multiple ball bearings that cannot be made below a minimum size. When compared to a roller screw of similar size and lead, the ball bearings' radius requires a coarser pitch resulting in fewer points of contact. This pitch combined with the smaller contact radius and a design that allows the bearings to contact each other, limits the ball screw's DLR leading to lower forces and shorter life than a roller screw.



DLR (Dynamic Load Rating) is an industry standard term that represents an applicable constant load (in direction and magnitude) where a ball bearing device (or power screw) will achieve 1,000,000 revolutions of rated life or L10 life estimation at 90% reliability.

PLANETARY ROLLER SCREW

Roller screws have significantly more contact points in the same space compared to ball screws

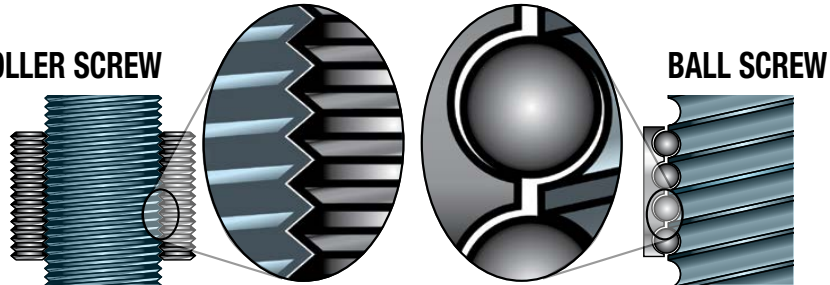

BALL SCREW

Estimating Life

NOTE: The L_{10} expected life of a roller screw is expressed as the linear travel distance that 90% of properly maintained roller screw manufactured are expected to meet or exceed. This is not a guarantee and the following equations should be used for estimation purposes only.

The underlying formula that defines this value is:

$$L_{10} = \left(\frac{C}{P_e} \right)^3 \cdot \ell \equiv$$

L_{10} Travel life in millions of units (in or mm), where:

C = Dynamic load rating (lbf) or (N)

P_e = Equivalent load (lbf) or (N)

If load is constant across all movements then:

actual load = equivalent load

ℓ = Screw lead (in/rev) (mm/rev)

Use the "Equivalent Load" calculation below, when the load is not constant throughout the entire stroke. In cases where there is only minor variation in loading, use greatest load for life calculations.

$$\text{Where: } P_e = \sqrt[3]{\frac{L_1(P_1)^3 + L_2(P_2)^3 + L_3(P_3)^3 + L_n(P_n)^3}{L}}$$

P_e = Equivalent load (lbf) or (N)

P_n = Each increment at different load (lbf) or (N)

L = Total distanced traveled per cycle (extend + retract stroke)
[$L = L_1 + L_2 + L_3 + L_n$]

L_n = Each increment of stroke at different load (in) or (mm)

PLANETARY ROLLER SCREWS

ENDURANCE TECHNOLOGYSM

Endurance Technology features are designed for maximum durability to provide extended service life.

A Tolomatic Design Principle

Tolomatic planetary roller screws offer machine designers a robust, compact, high force linear motion solution. Long life, flexible design, and efficient operation ensure minimal downtime and maximize ROI. Available in standard sizes, leads, and in lengths that are built-to-order.

PLANETARY ROLLERS

- Precision ground on state-of-the-art machines to small tolerances for smooth and efficient operation
- High dynamic load ratings for long life

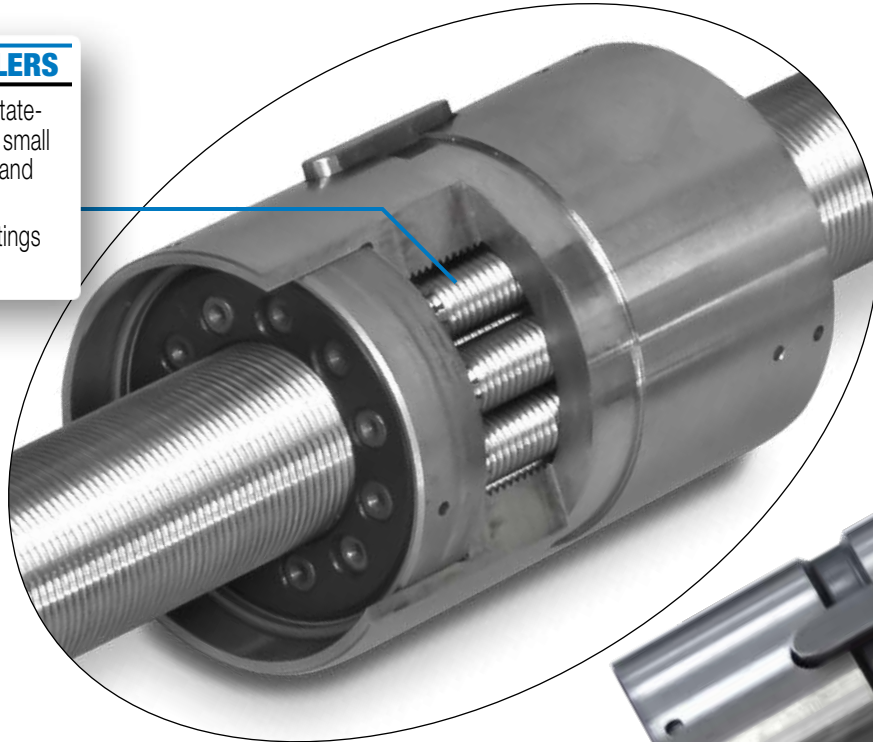

FAST DELIVERY*

*Lead times are dependent on quantity and machined end specifications

ROLLER NUT

Increased contact points for high load carrying capacity

ROLLER SCREW

State-of-the-art manufacturing coupled with extensive statistical testing methods ensures high performance within tight specifications

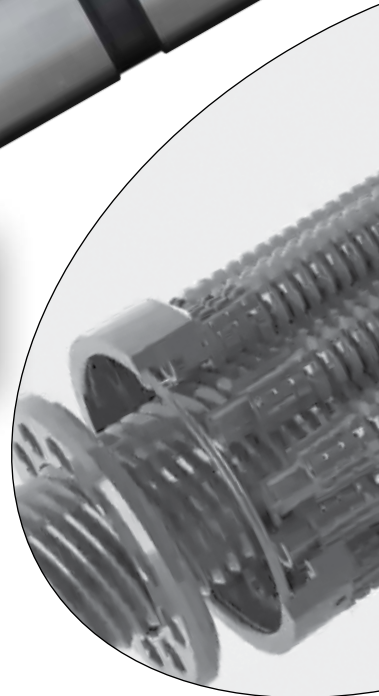

Tolomatic™... MAXIMUM DURABILITY

EXCELLENCE IN MOTION

HARDENED STEEL

- Screw, nut and rollers are manufactured with specially hardened steel for maximum durability and long life
- Designed and tested for demanding applications
- High load capacities

MACHINED ENDS

- Screw ends and bearing journals custom machined to fit most application requirements upon request
- Easy integration into machine designs and concepts

PLANETARY GEARS

High tech quality control & measurement lab assures superior performance for every component

SCREW SIZE	LEAD
<i>mm</i>	<i>mm</i>
15	4, 5, 10
20	4, 5, 10
30	5, 10
36	5, 10
39	10
48	12
63	10



tolomatic.com/ask
 Technical support
 before and after
 purchase

Planetary Roller Screws

DIMENSIONS & SPECIFICATIONS:

Cylinder; Size: 15, 20, 30, 36

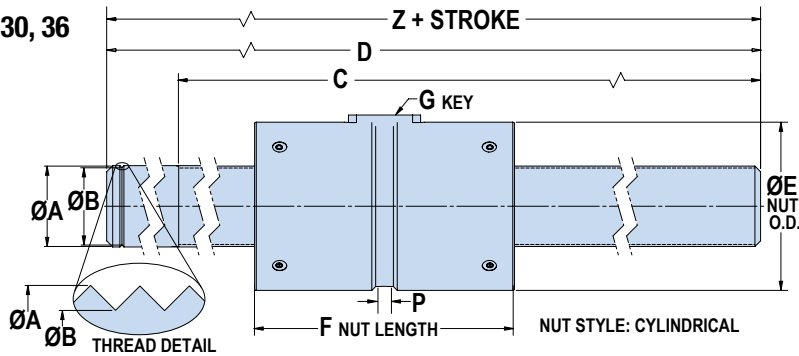

Flange; Size: 39, 48, 63

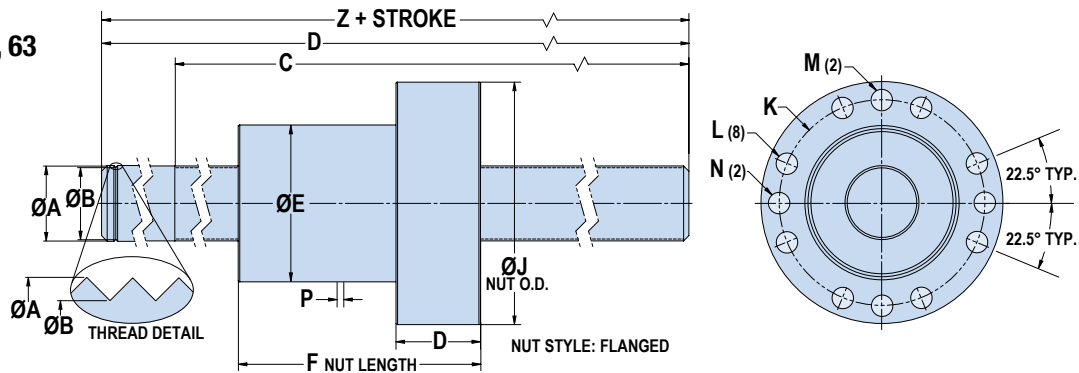

Size: All

CONFIG. CODE	SCREW SIZE	LEAD	DIMENSIONS											INERTIA				
			A	B	C	D	E	F	G	P	Z	DLR (G)	SLR (Co)	MAX. ROTATIONAL VELOCITY	SCREW	NUT	ROLLER	
			mm	mm	mm	mm	mm	mm	mm	mm	mm	mm	mm	mm	mm	kN	kN	RPM
CYLINDRICAL	15.4	15	4	15.29	14.59	743.9	990.6	34.983	44.88	4x4x14	2.0	291.58	41.1	38.7	5,500	0.95	35.78	1.28
	15.5	15	5	15.29	14.44	743.9	990.6	34.983	44.88	4x4x14	2.0	291.58	53.6	34.9	5,500	0.93	35.74	1.28
	15.10	15	10	15.55	13.94	743.9	990.6	34.983	44.88	4x4x14	2.0	291.58	47.2	47.3	5,500	0.92	36.32	1.28
	20.4	20	4	19.80	19.15	1,101.1	1,219.2	41.981	64.87	4x4x18	3.0	182.97	67.2	83.9	5,200	2.75	93.82	4.99
	20.5	20	5	19.80	19.05	1,101.1	1,219.2	41.981	64.87	4x4x18	3.0	182.97	73.3	70.9	5,200	2.70	84.96	4.87
	20.5XR	20	5	19.80	19.05	1,101.1	1,219.2	41.981	64.87	4x4x18	3.0	182.97	91.7	78.1	5,200	2.70	93.36	5.02
	20.10	20	10	20.07	18.37	1,101.1	1,219.2	41.981	64.87	4x4x18	3.0	182.97	76.4	74.0	5,200	2.63	93.60	4.85
	30.5	30	5	30.37	29.54	1,049.0	1,219.2	61.976	68.85	5x5x22	3.0	239.05	65.5	104.6	4,700	15.31	417.83	33.52
	30.10	30	10	30.71	29.10	1,049.0	1,219.2	61.976	68.85	5x5x22	3.0	239.05	116.1	105.0	4,700	15.27	429.39	33.43
	36.5	36	5	36.32	35.54	1,036.3	1,219.2	74.983	81.85	5x5x22	3.0	264.75	96.6	175.3	4,400	31.71	1,096.03	89.21
36.10	36	10	36.75	35.16	1,036.3	1,219.2	74.983	81.85	5x5x22	3.0	264.75	160.8	160.1	4,400	31.86	1,095.21	89.02	
FLANGED	39.10	39	10	39.70	38.11	1,003.3	1,219.2	80.000	91.83	—	See table below	307.73	182.7	214.3	4,200	43.70	3,001.59	116.09
	48.12	48	12	48.56	48.05	971.6	1,219.2	85.976	140.87	—		288.47	269.3	485.6	3,800	99.84	6,521.10	134.96
	63.10	63	10	63.70	62.18	906.8	1,219.2	126.974	169.80	—		482.20	442.9	818.7	3,000	298.59	43,326.34	990.57

Size: 39, 48, 63

CONFIG. CODE	SCREW SIZE	LEAD	FLANGE THICKNESS H	FLANGE DIAMETER J	BOLT CIRCLE K	HOLE DIAMETER L	HOLE DIAMETER M	HOLE DIAMETER N	LUBE PORT P	PILOT R
39.10	39	10	25.0	108.0	94.00	9.00	7.92 / 8.08	11.50	1/4-28 x 4.6mm	Ø72.08 / 73.02 x 2.02 DP
48.12	48	12	35.0	122.0	104.00	11.00	9.53 / 9.70	13.50	1/4-28 x 4.6mm	Ø78.00 / 78.04 x 2.02 DP
63.10	63	10	45.0	187.0	158.00	16.27	12.00 / 12.18	16.27	1/4-28 x 4.6mm	Ø116.86 / 116.90 x 3.30 DP

* For longer lengths, contact Tolomatic.

Screw Lead Accuracy: 0.023 mm/300 mm Backlash: 0.03 mm; for all sizes and leads

Planetary Roller Screws

Contact Tolomatic for pricing and to order



P R S 15	04 S M 15 0
MODEL	LEAD
PRS Planetary Roller Screw	See page 6 for valid roller screw lead & diameter combinations 04, 05, 10, 12
DIAMETER	STROKE LENGTH
15, 20, 30, 36, 39, 48, 63	SM ____ Enter desired stroke length in millimeters (round to nearest mm) See page 6 for maximum stroke length for DIAMETER and LEAD chosen

To order with machined ends contact Tolomatic

Selection Formula

Use the following equations to help verify your choice of roller screw. Visit tolomatic.com/ask for tech support.

<p>Critical speed of screw shaft (RPM)</p>	$n_{cr} = 490 \cdot 10^5 \cdot \frac{f_1 A}{l^2}$	<p>A = nominal diameter (mm) l = free length, or the distance between the two support bearings (mm) f₁ = mounting correction factor (see below)</p>
<p>Buckling strength (N)</p>	$F_c = \frac{34,000 \cdot f_3 \cdot B^4}{l^2}$	<p>B = root diameter (mm) l = free length, or the distance between the two support bearings (mm) f₃ = mounting correction factor (see below)</p>

	MOUNTING CORRECTION FACTOR
<p>Fixed-free arrangements provide the least rigidity.</p>	<p>f₁ = 0.90 f₃ = 0.25</p>
<p>Supported-supported arrangements include a simple radial bearing at each end.</p>	<p>f₁ = 2.50 f₃ = 1.00</p>
<p>A fixed-supported arrangement has bearings at both ends, with a thrust bearing at the motor end.</p>	<p>f₁ = 3.80 f₃ = 2.00</p>
<p>A fixed-fixed arrangement provides maximum rigidity.</p>	<p>f₁ = 5.60 f₃ = 4.00</p>

The Tolomatic Difference Expect More From the Industry Leader:



INNOVATIVE PRODUCTS

Solutions with Endurance TechnologySM for challenging applications.



FAST DELIVERY

Built-to-order with configurable stroke lengths and flexible mounting options.



ACTUATOR SIZING

Size and select electric actuators with our online software.



YOUR MOTOR HERE[®]

Match your motor to compatible mounting plates with Tolomatic actuators.



CAD LIBRARY

Download 2D or 3D CAD files for Tolomatic products.



TECHNICAL SUPPORT

Get a question answered or request a virtual design consultation with one of our engineers.

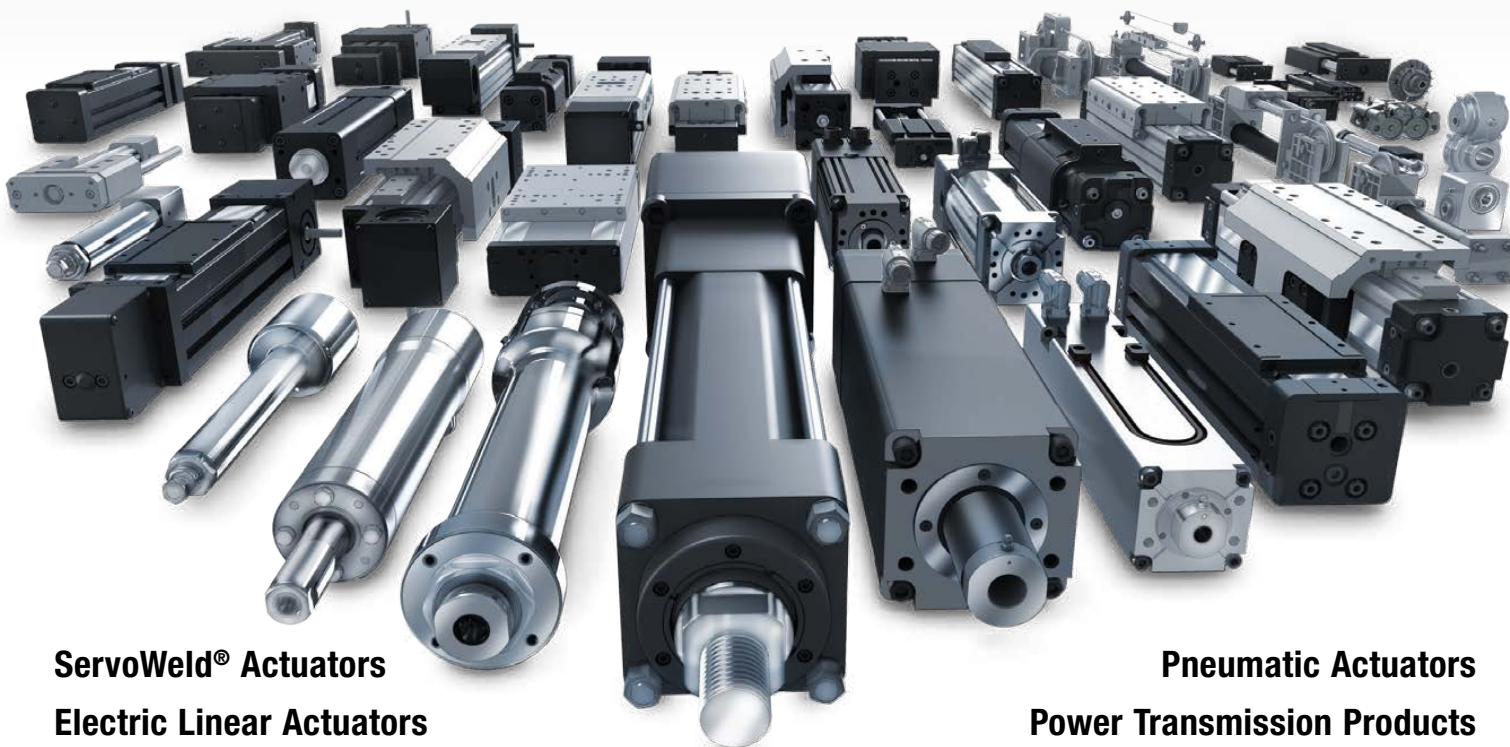

ServoWeld[®] Actuators
Electric Linear Actuators

Pneumatic Actuators
Power Transmission Products



MADE IN U.S.A.

TolomaticTM
EXCELLENCE *IN* MOTION

COMPANY WITH
QUALITY SYSTEM
CERTIFIED BY DNV
= ISO 9001 =
Certified site: Hamel, MN

USA - Headquarters

Tolomatic Inc.

3800 County Road 116
Hamel, MN 55340, USA

Phone: (763) 478-8000

Toll-Free: **1-800-328-2174**

sales@tolomatic.com

www.tolomatic.com

MEXICO

Centro de Servicio

Parque Tecnológico Innovación
Int. 23, Lateral Estatal 431,
Santiago de Querétaro,

El Marqués, México, C.P. 76246

Phone: +1 (763) 478-8000

help@tolomatic.com

EUROPE

Tolomatic Europe GmbH

Elisabethenstr. 20
65428 Rüsselsheim
Germany

Phone: +49 6142 17604-0

help@tolomatic.eu

www.tolomatic.com/de-de

CHINA

Tolomatic Automation Products (Suzhou) Co. Ltd.

No. 60 Chuangye Street, Building 2
Huqiu District, SND Suzhou
Jiangsu 215011 - P.R. China

Phone: +86 (512) 6750-8506

Tolomatic_China@tolomatic.com

All brand and product names are trademarks or registered trademarks of their respective owners. Information in this document is believed accurate at time of printing. However, Tolomatic assumes no responsibility for its use or for any errors

that may appear in this document. Tolomatic reserves the right to change the design or operation of the equipment described herein and any associated motion products without notice. Information in this document is subject to change without notice.

Visit www.tolomatic.com for the most up-to-date technical information