

ENDURANCE TECHNOLOGYSM
A Tolomatic Design Principle

**RSH ELECTRIC
HYGIENIC
ROD-STYLE
ACTUATOR**

PATENT PENDING



LINEAR SOLUTIONS MADE EASY

RSH – Hygienic Electric Rod-Style Actuator





All 316 stainless steel construction and IP69K environmental rating make the RSH Hygienic rod-style actuators ideal for food, beverage, and pharmaceutical automation machinery.

Designed to Meet Hygienic Guidelines for:

- USDA
- BISSC
- EHEDG
- NSF/3-A

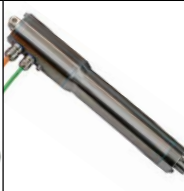

TOLOMATIC'S ELECTRIC ROD-STYLE ACTUATORS

	ERD	RSH	RSA	GSA	RSX	IMA
						
	Rod-Style Actuator	Hygienic Rod-Style Actuator	Rod-Style Actuator	Guided Rod-Style Actuator	Rod-Style Actuator	Integrated Servo Actuator
Force up to:	500 lbf (2.2 kN)	7,900 lbf (35.3 kN)	13,000 lbf (58.0 kN)	950 lbf (4.2 kN)	50,000 lbf (222.4 kN)	2,500 lbf (2.5 kN)
Speed up to:	58 in/sec (1,473 mm/sec)	20 in/sec (500 mm/sec)	123 in/sec (3,124 mm/sec)	123 in/sec (3,124 mm/sec)	30 in/sec (760 mm/sec)	20 in/sec (500 mm/sec)
Stroke Length up to:	24 in (610 mm)	48 in (1,200 mm)	60 in (1,520 mm)	36 in (910 mm)	35 in (890 mm)	18 in (460 mm)
Screw/Nut Type	Solid & Ball	Ball & Roller	Solid, Ball & Roller	Solid & Ball	Roller	Ball & Roller
<i>For complete information see www.tolomatic.com or literature number:</i>						
Literature Number:	2190-4000	2100-4010	3600-4166	3600-4166	2171-4001	2700-4014

(Not all models deliver maximum values listed, i.e.: Maximum thrust may not be available with maximum speed)

RSH – Improving upon the ERD Hygienic

Features: **ERD**



THREADED ROD END

- Compatible with many commercially available metric rod end accessories
- Standard metric threads

GREASE PORT

- Screw re-lubrication system provides extended screw life
- Convenient lubrication without disassembly

SMOOTH EXTERIOR

Polished, contoured mating surface designed to provide IP69K seal for today's hygienic servo motors

WELDED SEAMS

Leaving no gaps which eases cleanup and helps to prevent bacterial growth

STATIC IP69K OPTION

- To withstand high-pressure wash-down
- Clean-in-place compatible

BREATHER/PURGE PORT

Helps prevent contaminants from entering into actuator

Improvements: **RSH**

ROBUST DESIGN

- Up to 89% higher force capability for the RSH22 ball screw options
- Increased DLR ratings on most screw options

FRONT FACE SEALING O-RING

Hygienic design from head to toe

THREADED ROD END

- Compatible with many commercially available metric rod end accessories
- Standard metric threads

GREASE PORT

- Screw re-lubrication system provides extended screw life
- Convenient lubrication without disassembly

CARTRIDGE W/ REPLACEABLE SEALS

Quick seal cartridge replacement without special tools

DUAL SEAL SYSTEM

Use the dual seal system that provides the longest life in your application

ALL POLISHED 316 STAINLESS STEEL WITH SMOOTH EXTERIOR

- 316 series stainless steel for corrosion resistance
- Simplifies and lowers cost of machine design by eliminating the need for protective guards around standard actuators

WELDED SEAMS

Leaving no gaps which eases cleanup and helps to prevent bacterial growth

STATIC IP69K RATED (STANDARD)

- To withstand high-pressure wash-down
- Clean-in-place compatible

HYGIENIC BREATHER/PURGE PORT

Helps prevent contaminants from entering into actuator

HYGIENIC STAINLESS STEEL FASTENERS

- Standard metric threads
- Hex fasteners for sturdy construction without potential particle collection areas
- Included for your motor: EHEDG compliant 316 stainless seal sealed bolts



RSH HYGIENIC ELECTRIC ROD STYLE ACTUATOR

ENDURANCE TECHNOLOGYSM

Endurance Technology features are designed for maximum durability to provide extended service life.

A Tolomatic Design Principle

The all 316 series stainless-steel RSH Hygienic Electric Rod Style Actuator incorporates hygienic design principles and has an IP69K rating (static). Available in 22, 25 & 30 sizes, the RSH is built-to-order in stroke lengths up to 48" (1,220 mm) with force up to 7,900 lbf (35.3 kN).

ALL POLISHED 316 STAINLESS STEEL CONSTRUCTION

- 316 series stainless steel for corrosion resistance
- Simplifies and lowers cost of machine design by eliminating the need for protective guards around standard actuators

HYGIENIC SEALING DESIGN FOR FRONT FACE MOUNTING

Hygienic design from head to toe

THREADED ROD END

- Compatible with many commercially available metric rod end accessories
- Standard metric threads

GREASE PORT

- Screw re-lubrication system provides extended screw life
- Convenient lubrication without disassembly

REPLACEABLE SEALS

Quick seal cartridge replacement without special tools

DUAL SEAL SYSTEM

Use the dual seal system that provides the longest life in your application

Seal Option	Seal Materials	Usage
PSL	Polyurethane/ Polyurethane Rod Seals (Standard)	Longest Lasting for Most Applications. High Tolerance of Abrasives Like Salt and Sugar
USL	Polyurethane/ UHMWPE Rod Seals (Severe Chemical)	Use When High Concentrations of Caustic Chemicals are Present Including Ammonium Chloride and Hydrogen Peroxide.

Tolomatic™... MAXIMUM DURABILITY

EXCELLENCE IN MOTION

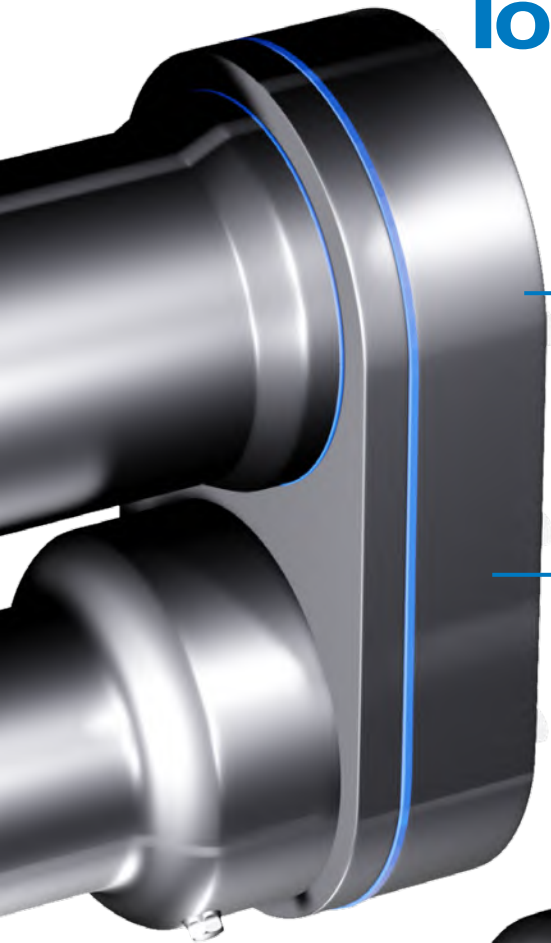

SMOOTH EXTERIOR

Polished, contoured mating surface designed to provide IP69K seal for today's hygienic servo motors

NEXT GENERATION RP DESIGN

- IP69k hygienic design
- Easy belt tensioning with no need to reposition motor
- Hygienic YMH (Your Motor Here) stainless steel compatible

IP69K RATED

- To withstand high-pressure wash-down
- Clean-in-place compatible

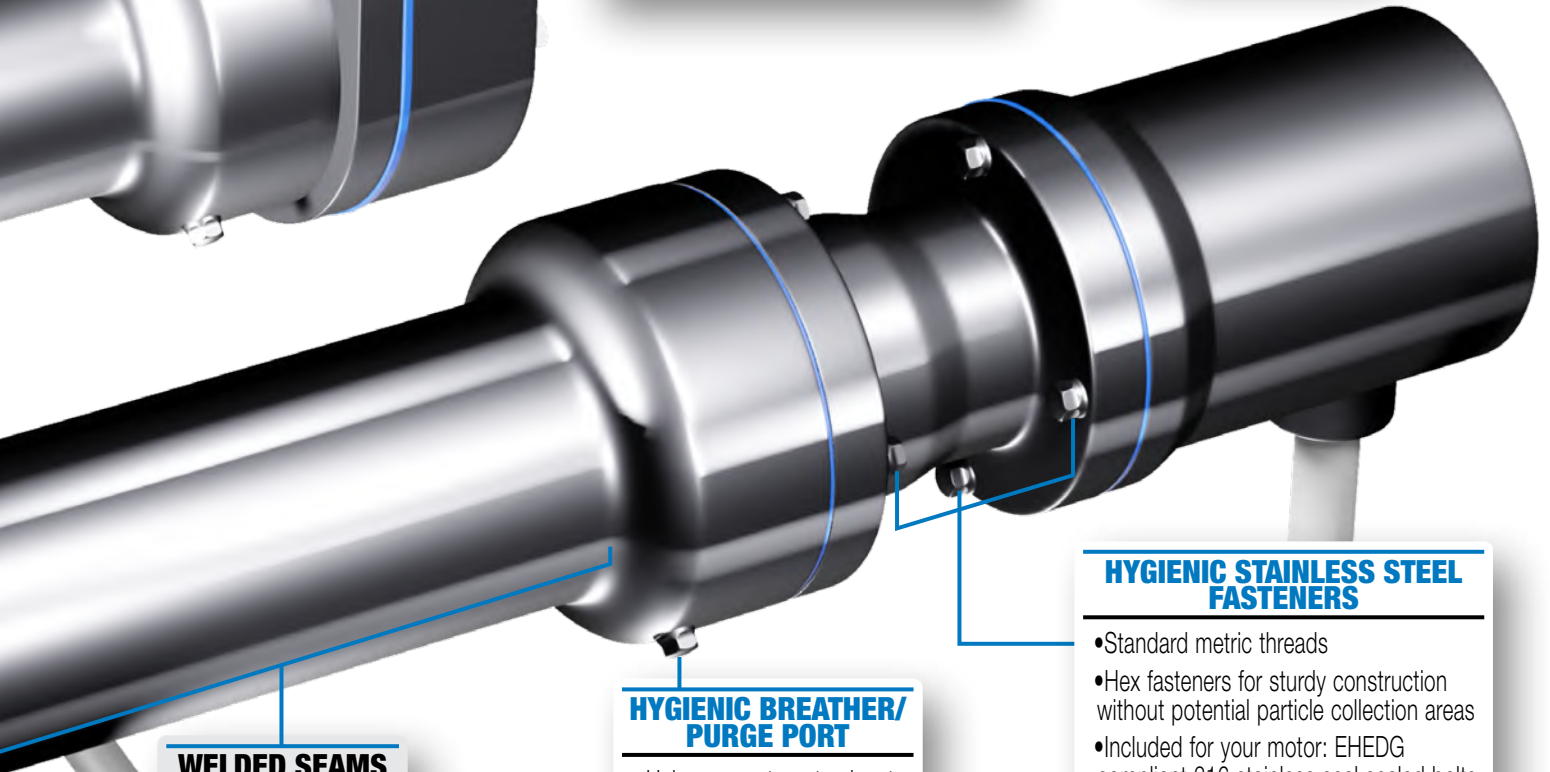

WELDED SEAMS

Leaving no gaps which eases cleanup and helps to prevent bacterial growth

HYGIENIC BREATHER/ PURGE PORT

Helps prevent contaminants from entering into actuator

HYGIENIC STAINLESS STEEL FASTENERS

- Standard metric threads
- Hex fasteners for sturdy construction without potential particle collection areas
- Included for your motor: EHEDG compliant 316 stainless seal sealed bolts

POLISHED EXTERIOR

Polished surface finish reduces bacterial growth and meets hygienic design guidelines.

MULTIPLE SCREW TECHNOLOGIES

ROLLER NUT

Roller nuts provide the highest thrust and life ratings available



SCREW ACCURACY

$\pm 0.0102\text{mm}/300\text{mm}; \pm 0.0004\text{"/ft.}$

BALL NUT

Ball nuts offer efficiency at a cost effective price



SCREW ACCURACY

$\pm 0.051\text{mm}/300\text{mm}; \pm 0.002\text{"/ft.}$

RSH – Hygienic Electric Actuator



SIZE: ALL

SPECIFICATIONS

SPECIFICATIONS (US conventional measurement)

RSH SIZE	MAXIMUM STROKE	SCREW CODE	LEAD	LEAD ACCURACY	BACKLASH	MAXIMUM THRUST	DYNAMIC LOAD RATING	INERTIA			WEIGHT		
								LMI	RP	Per Inch	LMI	RP	Per Inch
								Base	Base		Base	Base	
in	in/rev	in/ft	in	lbf	lbf	lb-in ²	lb-in ²	lb-in ²	lb	lb	lb		
22	39.4	BNM05	0.197	0.0040	0.0028	1,700	3,080	0.776	0.410	0.009	11.6	18.9	0.45
	39.4	BNM10	0.394	0.0040	0.0028	1,700	4,721	0.778	0.412	0.010	11.5	18.9	0.45
	39.4	BNM20	0.787	0.0040	0.0028	1,000	2,248	0.781	0.415	0.011	11.6	18.9	0.45
	24.0	RN04	0.157	0.0004	0.0012	1,700	6,409	0.758	0.392	0.004	12.5	19.9	0.38
	24.0	RN05	0.197	0.0004	0.0012	1,700	6,409	0.758	0.392	0.004	12.5	19.9	0.38
	24.0	RN10	0.397	0.0004	0.0012	1,556	6,409	0.758	0.392	0.004	12.5	19.9	0.38
25	39.4	BN04	0.250	0.0040	0.0150	2,846	3,250	7.820	3.433	0.028	34.8	40.2	0.84
	39.4	BNM05	0.197	0.0020	0.0024	2,000	3,777	7.795	3.408	0.022	34.3	39.7	0.82
	39.4	BNM10	0.394	0.0020	0.0024	1,750	5,171	7.795	3.408	0.022	34.7	40.1	0.82
	39.4	BNM25	0.984	0.0040	0.0031	700	4,496	7.804	3.417	0.024	34.5	39.9	0.83
	36.0	RN04	0.157	0.0004	0.0012	4,159	12,917	7.742	3.355	0.010	36.8	42.2	0.79
	36.0	RN05	0.197	0.0004	0.0012	3,878	12,917	7.742	3.355	0.010	36.8	42.2	0.79
30	36.0	RN10	0.394	0.0004	0.0012	4,159	12,917	7.745	3.358	0.011	36.8	42.2	0.79
	48.0	BN04	0.250	0.0040	0.0150	4,500	4,250	8.435	4.053	0.141	41.2	46.6	1.30
	48.0	BNM05	0.197	0.0010	0.0024	3,000	5,598	8.504	4.122	0.155	42.3	47.7	1.32
	48.0	BNM10	0.394	0.0020	0.0031	2,950	9,757	8.428	4.046	0.140	43.7	49.1	1.32
	48.0	BNM20	0.787	0.0020	0.0031	1,848	9,622	8.429	4.047	0.140	41.8	47.2	1.32
	36.0 [§]	RN05	0.197	0.0004	0.0012	7,868	12,917	8.018	3.636	0.057	43.5	48.9	1.16
36.0 [§]	RN10	0.394	0.0004	0.0012	7,943	12,917	8.032	3.650	0.060	43.5	48.9	1.16	

[§] RSH30 extended stroke length 50" (1270mm) available for roller screws, contact Tolomatic for production time.

*Standard Temperature range	-4° to 104° F (-20° to 40° C)
IP rating	69k (static) standard for 22, 25, 30 sizes

*Contact Tolomatic to review application for operations outside the standard temperature range.

SIDE LOAD CONSIDERATIONS

The standard RSH rod-style actuator is not meant to be used in applications where side loading occurs.

Loads must be guided and supported. Loads should be aligned with the line of motion of the thrust rod.

Side loading will affect the life of the actuator.

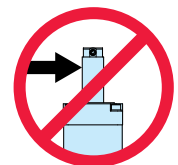

SCREW CODE	DESCRIPTION
BN	Ball Nut
BNM	Ball Nut Metric
RN	Roller Nut



RSH – Hygienic Electric Rod-Style Actuator



SIZE: ALL

SPECIFICATIONS

SPECIFICATIONS (metric measurement)

RSH SIZE	MAXIMUM STROKE	SCREW CODE	LEAD	LEAD ACCURACY	BACKLASH	MAXIMUM THRUST	DYNAMIC LOAD RATING	INERTIA			WEIGHT		
								LMI	RP	Per 25mm	LMI	RP	Per 25mm
								Base	Base	Per 25mm	Base	Base	Per 25mm
mm	mm/rev	mm/300mm	mm	N	N	kg-m ² x 10 ⁻⁶	kg-m ² x 10 ⁻⁶	kg-m ² x 10 ⁻⁶	kg	kg	kg		
22	1000.0	BNM05	5.00	0.100	0.070	7,562	13,700	227.26	120.04	2.66	5.3	8.6	0.20
	1000.0	BNM10	10.00	0.100	0.070	7,562	21,000	227.82	120.60	2.84	5.2	8.6	0.20
	1000.0	BNM20	20.00	0.100	0.070	4,448	10,000	228.89	121.67	3.14	5.3	8.6	0.20
	609.6	RN04	4.00	0.010	0.030	7,562	28,509	221.95	114.74	1.07	5.7	9.0	0.17
	609.6	RN05	5.00	0.010	0.030	7,562	28,509	221.96	114.74	1.07	5.7	9.0	0.17
	609.6	RN10	10.00	0.010	0.030	6,921	28,509	221.98	114.76	1.07	5.7	9.0	0.17
25	1000.0	BN04	6.35	0.100	0.380	12,659	14,456	2,291.38	1,005.99	8.15	15.8	18.2	0.38
	1000.0	BNM05	5.00	0.052	0.060	8,896	16,800	2,283.96	998.56	6.51	15.6	18.0	0.37
	1000.0	BNM10	10.00	0.052	0.060	7,784	23,000	2,283.99	998.60	6.51	15.7	18.2	0.37
	1000.0	BNM25	25.00	0.100	0.080	3,114	20,000	2,286.68	1,001.29	7.07	15.6	18.1	0.38
	914.4	RN04	4.00	0.010	0.030	18,499	57,456	2,268.34	982.95	3.02	16.7	19.1	0.36
	914.4	RN05	5.00	0.010	0.030	17,249	57,456	2,268.35	982.96	3.02	16.7	19.1	0.36
914.4	RN10	10.00	0.010	0.030	18,499	57,456	2,269.17	983.78	3.18	16.7	19.1	0.36	
30	1219.2	BN04	6.35	0.100	0.380	20,016	18,904	2,471.55	1,187.63	41.29	18.7	21.1	0.59
	1219.2	BNM05	5.00	0.023	0.060	13,344	24,900	2,491.73	1,207.81	45.33	19.2	21.6	0.60
	1219.2	BNM10	10.00	0.052	0.080	13,122	43,400	2,469.37	1,185.45	41.02	19.8	22.3	0.60
	1219.2	BNM20	20.00	0.052	0.080	8,220	42,800	2,469.58	1,185.65	41.04	19.0	21.4	0.60
	914.4 [§]	RN05	5.00	0.010	0.030	34,997	57,456	2,349.33	1,065.40	16.78	19.7	22.2	0.53
	914.4 [§]	RN10	10.00	0.010	0.030	35,330	57,456	2,353.24	1,069.32	17.55	19.7	22.2	0.53

[§] RSH30 extended stroke length 50" (1270mm) available for roller screws, contact Tolomatic for production time.

What is an IP Rating?

The IP Code (or Ingress Protection Rating) consists of the letters IP followed by two digits and an optional letter. As defined in international standard IEC 60529, it classifies the degrees of protection provided against the intrusion of solid objects (including body parts like hands and fingers), dust, accidental contact, and water in electrical enclosures.

The IP69K test specifies a spray nozzle that is fed with 80°C water at 8–10 MPa (80–100 bar) and a flow rate of 14–16 L/min. The nozzle is held 10–15 cm from the tested device at angles of 0°, 30°, 60° and 90° for 30 s each. The test device sits on a turntable that rotates once every 12 s (5 rpm).

SOLIDS, FIRST DIGIT:

6	Dust tight	No ingress of dust; complete protection against solid object intrusion
---	------------	--

LIQUIDS, SECOND DIGIT (static rating)

9K	High pressure, high temp. wash-down	As above, plus ingress of water in harmful quantity shall not be possible when the enclosure is subject to high pressure, high temperature wash-down.
----	-------------------------------------	---

What Does IP69K mean?

German standard DIN 40050-9 extends the IEC 60529 rating system described above with an IP69K rating for high-pressure, high-temperature wash-down applications.[4] Such enclosures must not only be dust tight (IP6X), but also able to withstand high-pressure and steam cleaning.

The first digit indicates the level of protection that the enclosure provides against access to hazardous parts (e.g., electrical conductors, moving parts) and the ingress of solid foreign objects.

The second digit indicates the level of protection that the enclosure provides against harmful ingress of water.

RSH – Hygienic Rod-Style Actuator

sizeit.tolomatic.com
for fast, accurate
actuator selection

SIZE: RSH22

SPECIFICATIONS

CRITICAL SPEED CAPACITY (NOTE: Max. 19.6 in/sec critical speed is limited by the seal not the screw)

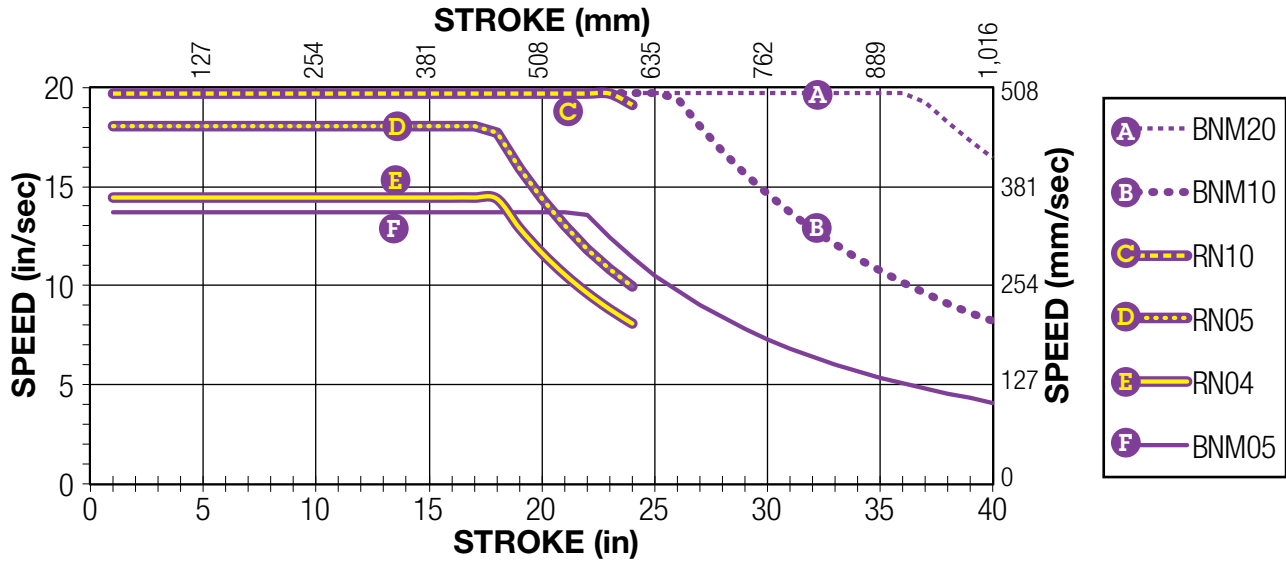

MAXIMUM THRUST vs STROKE

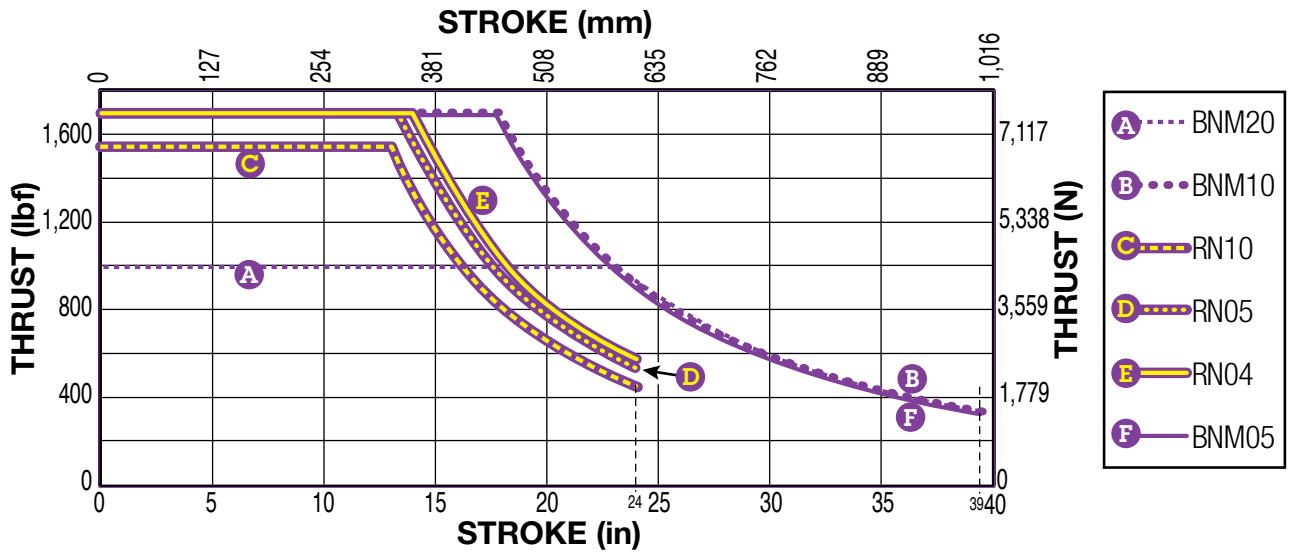

SCREW LIFE

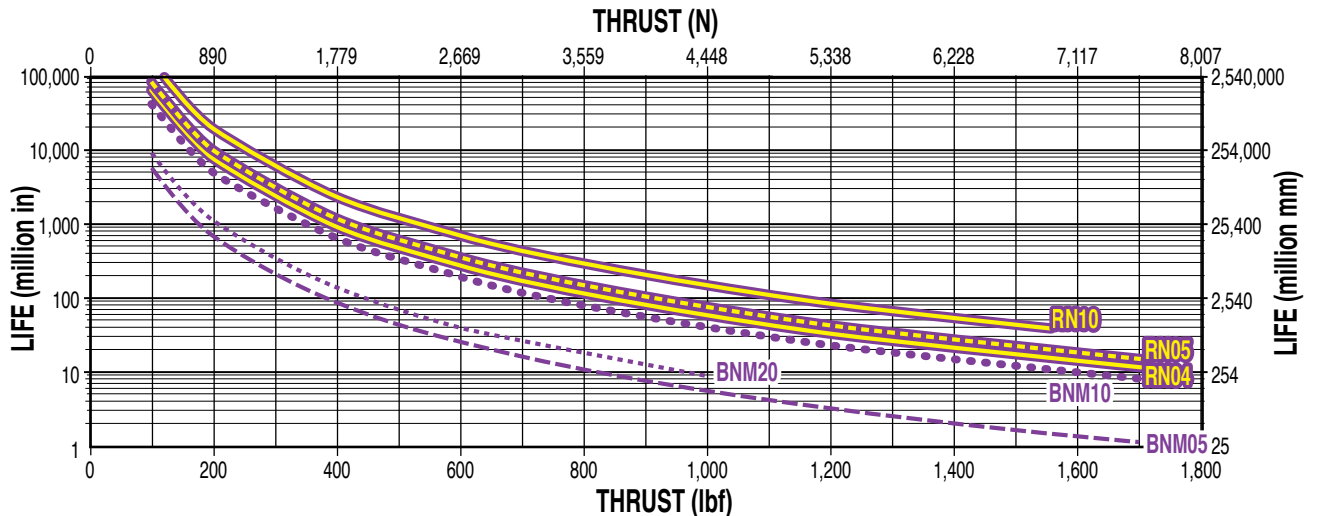

RSH – Hygienic Electric Rod-Style Actuator



SIZE: RSH25

SPECIFICATIONS

CRITICAL SPEED CAPACITY (NOTE: Max. 19.6 in/sec critical speed is limited by the seal not the screw)

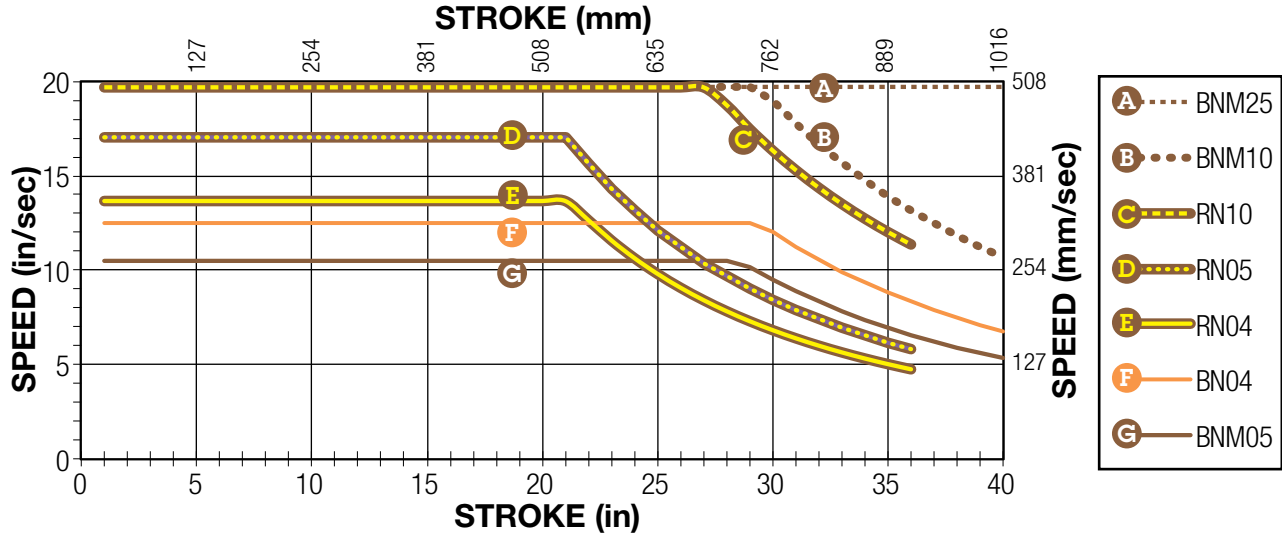

MAXIMUM THRUST vs STROKE

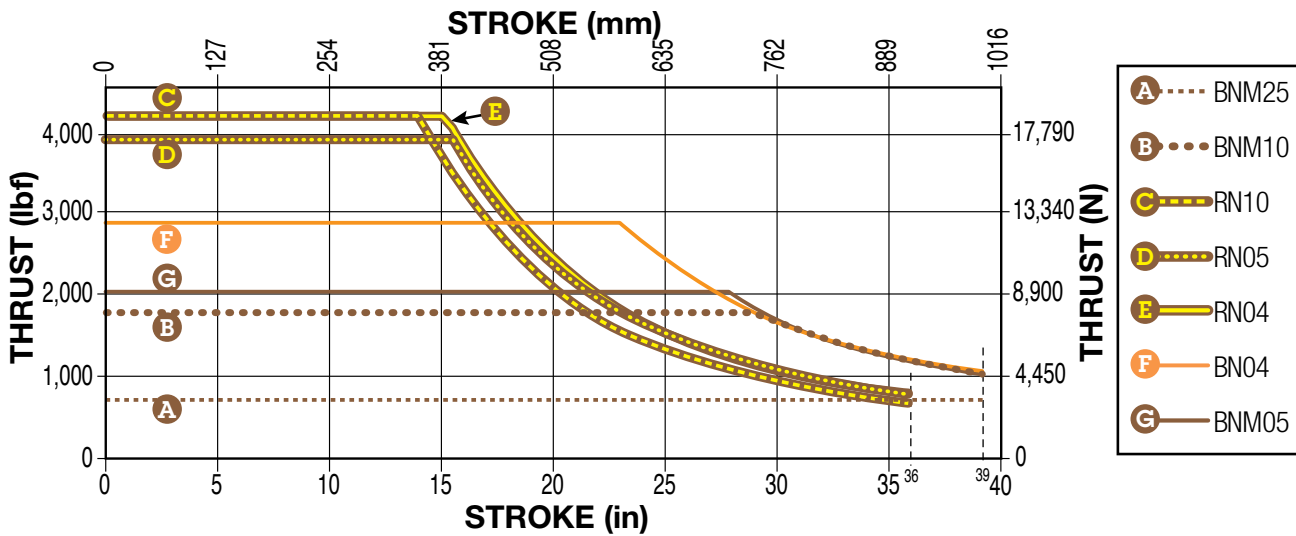

SCREW LIFE

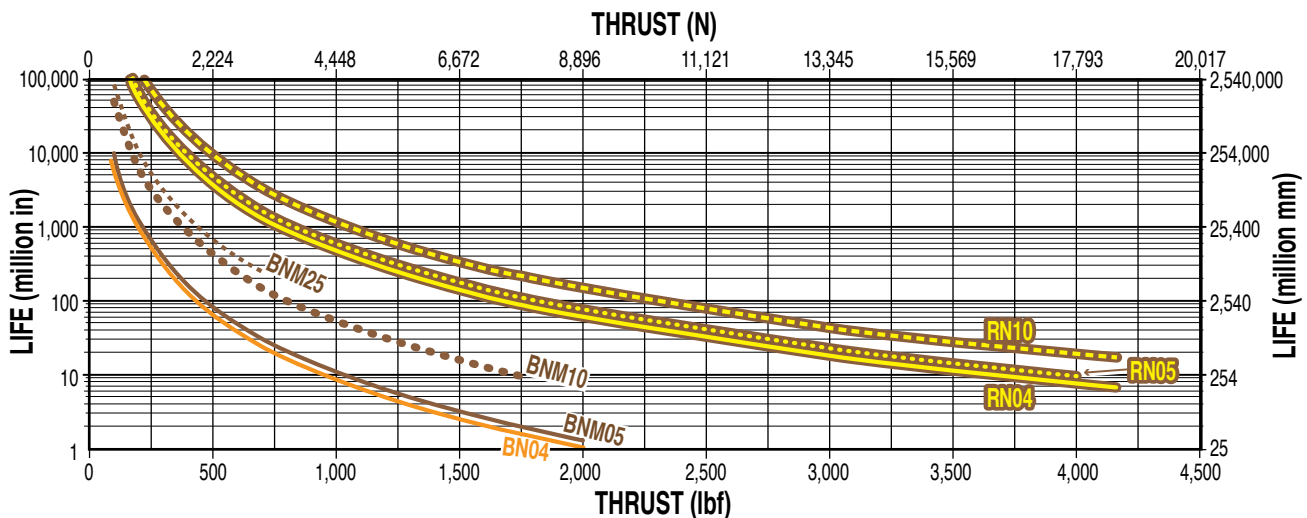

RSH – Hygienic Rod-Style Actuator



SIZE: RSH30

SPECIFICATIONS

CRITICAL SPEED CAPACITY (NOTE: Max. 19.6 in/sec critical speed is limited by the seal not the screw)

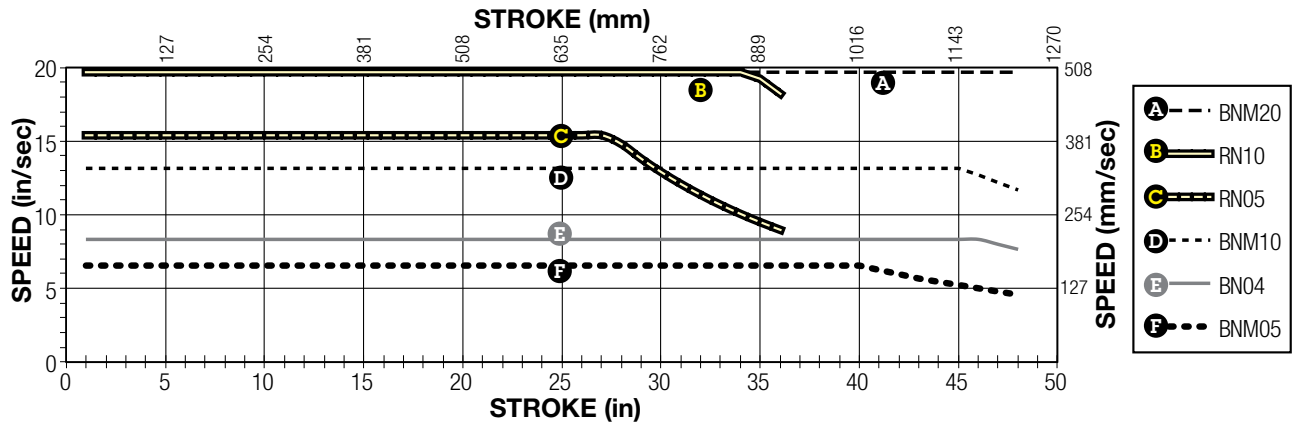

MAXIMUM THRUST vs STROKE

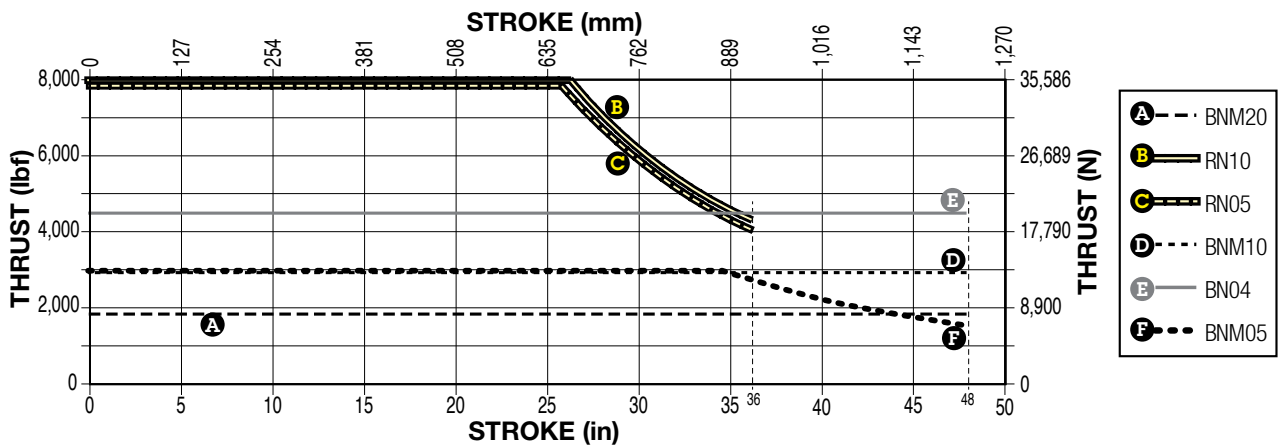

SCREW LIFE

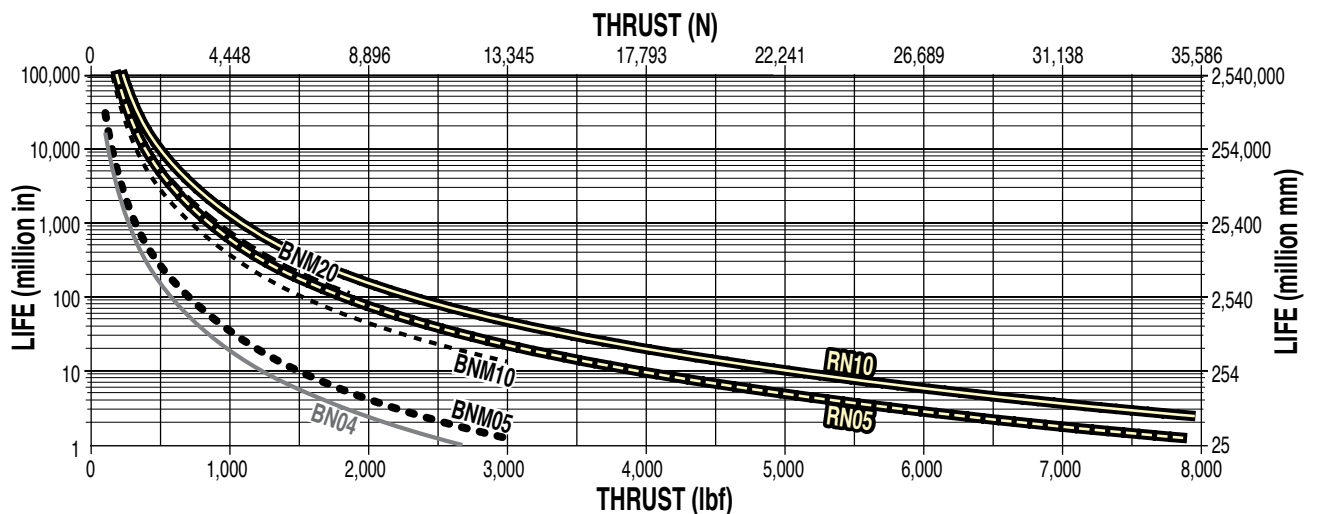

RSH – Hygienic Electric Rod-Style Actuator



SIZE: **22, 25, 30**

SPECIFICATIONS

RE-LUBRICATION RECOMMENDATION:

RSH22, RSH25, RSH30: RSH Lubrication requirements for electric actuators depend on the motion cycle (velocity, force, duty cycle), type of application, ambient temperature, environmental surrounding and various other factors. For many general purpose applications, Tolomatic ball screw actuators are typically considered lubricated for life unless otherwise specified, such as those actuator models outfitted with a re-lubrication feature. For roller screw or ball screw actuators outfitted with a re-lubrication feature, Tolomatic recommends to re-lubricate the actuator at least once per year or every 1,000,000 cycles, whichever comes first, to maximize service life. For more demanding applications such as pressing, high frequency or other highly stressed applications, the re-lubrication interval

for these actuators will vary and will need to be more frequent. In these demanding applications, it is recommended to execute at least 5 full stroke moves every 5,000 cycles of operation (or more frequent if possible) to re-distribute the grease within the actuator.

Re-lubricate with Tolomatic Grease into the grease zerk located in the rod end.

	RSH22	RSH25	RSH30
Qty. 2.5g+(0.010x \$mm)	4.8g+(0.010x \$mm)	5.3g+(0.018x \$mm)	
Qty. 0.09oz+(0.009x \$in)	0.17oz+(0.009x \$in)	0.19oz+(0.016x \$in)	

\$ = Stroke length (mm or in)

⚠ In some applications oil may leak from the grease zerk. In contamination sensitive applications replace grease zerk with plug.

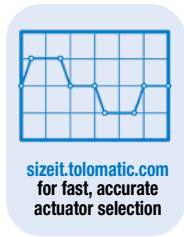

USE THE TOLOMATIC SIZING AND SELECTION SOFTWARE AVAILABLE ONLINE AT www.tolomatic.com OR... CALL TOLOMATIC AT 1-800-328-2174.

We will provide any assistance needed to determine the proper actuator for the job.

MOTOR CHOICES - YOUR MOTOR HERE

ADD ANY MOTION SYSTEM TO OUR ACTUATORS

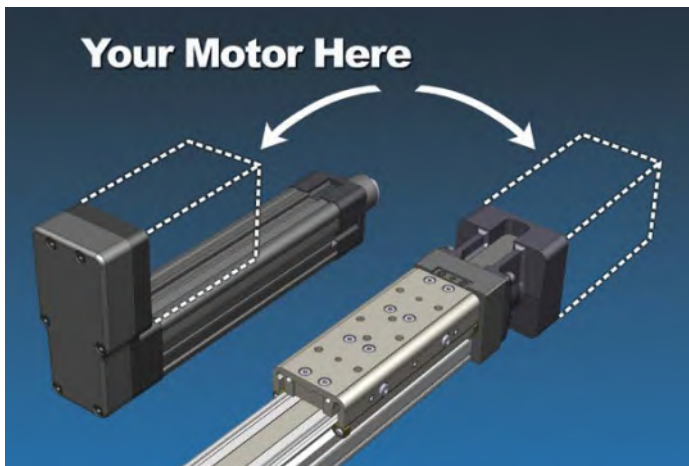

"YOUR MOTOR HERE" MADE-TO-ORDER MOTOR MOUNTS.

Select a high-performance Tolomatic electric actuator and we'll provide a motor-specific interface for your motor. With our online database, you can select from several stainless steel motor manufacturers and models.

Visit www.tolomatic.com/ymh to find your motor/actuator match!



The RSH utilizes Tolomatic's YMH (Your Motor Here) program. See www.tolomatic.com/ymh or consult Tolomatic sales at 1-800-328-2174 for details.

Configure an actuator and a complete motion control system today using Tolomatic's easy-to-use on-line sizing & selection

RSH – Hygienic Electric Rod-Style Actuator



tolomatic.com/CAD
 Download 3D CAD
 Always use CAD solid model to
 determine critical dimensions

SIZE: 22, 25, 30

DIMENSIONS

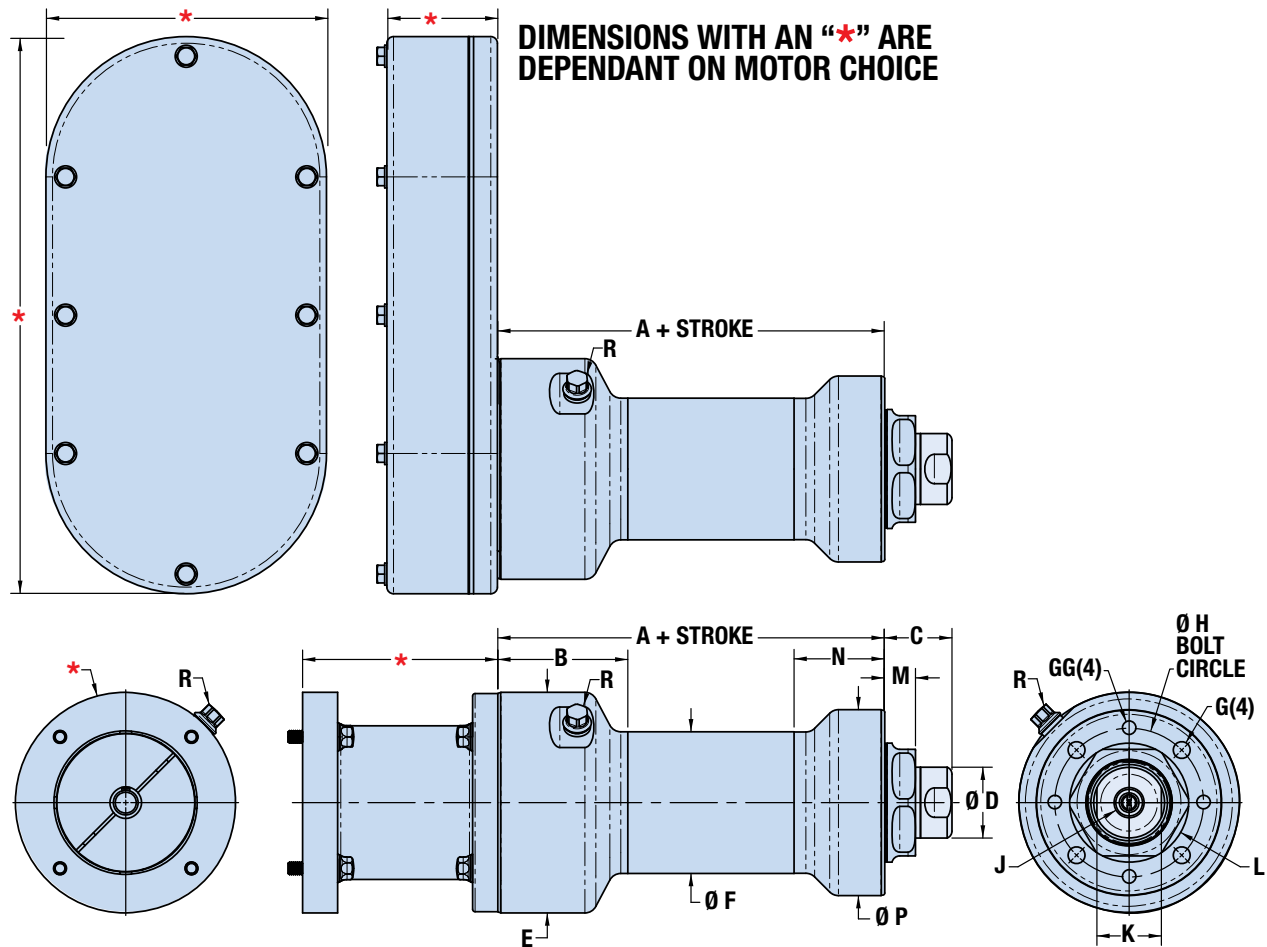

	A	B	C	ØD	ØE	ØF	G	GG	ØH	J	K	L	M	N	ØP
RSH22	6.14	2.06	1.08	1.13	3.50	2.25	M8 x 1.25 \downarrow 0.63"	M6 x 1.0 \downarrow 0.47"	2.362	M12x1.25 \downarrow 0.87"	1.02	1.890 1.888	0.50	1.43	2.95
RSH25	8.31	2.70	1.39	1.38	4.92	3.50	M10x1.50 \downarrow 0.79"	M8x1.25 \downarrow 0.63"	2.756	M20x1.5 \downarrow 1.00"	1.18	2.205 2.203	0.52	1.86	3.50
RSH30	9.34	2.70	1.39	2.13	4.92	3.50	M12x1.75 \downarrow 0.95"	M10x1.50 \downarrow 0.79"	3.701	M27x2.0 \downarrow 1.30"	1.97	3.071 3.069	0.55	2.13	4.49

Dimensions in inches

R M5x0.8x10 plug

	A	B	C	ØD	ØE	ØF	G	GG	ØH	J	K	L	M	N	ØP
RSH22	155.9	52.4	27.3	28.6	89.0	57.2	M8x1.25 \downarrow 16.0	M6x1.0 \downarrow 12.0	60.00	M12x1.25 \downarrow 22.2	26.0	48.00 47.95	12.6	36.4	75.0
RSH25	211.2	68.5	35.3	35.0	125.0	89.0	M10x1.50 \downarrow 20.0	M8x1.25 \downarrow 16.0	70.00	M20x1.5 \downarrow 25.4	30.0	56.00 55.95	13.3	47.2	89.0
RSH30	237.2	68.5	35.3	54.0	125.0	89.0	M12x1.75 \downarrow 24.0	M10x1.50 \downarrow 24.0	94.00	M27x2.0 \downarrow 33.0	50.0	78.00 77.95	13.8	54.0	114.0

Dimensions in millimeters



sizeit.tolomatic.com
 for fast, accurate
 actuator selection

RSH – Hygienic Electric Rod-Style Actuator



tolomatic.com/CAD
 Download 3D CAD
 Always use CAD solid model to
 determine critical dimensions

SIZE: 22, 25, 30

DIMENSIONS

FFG - FRONT FLANGE MOUNT OPTION

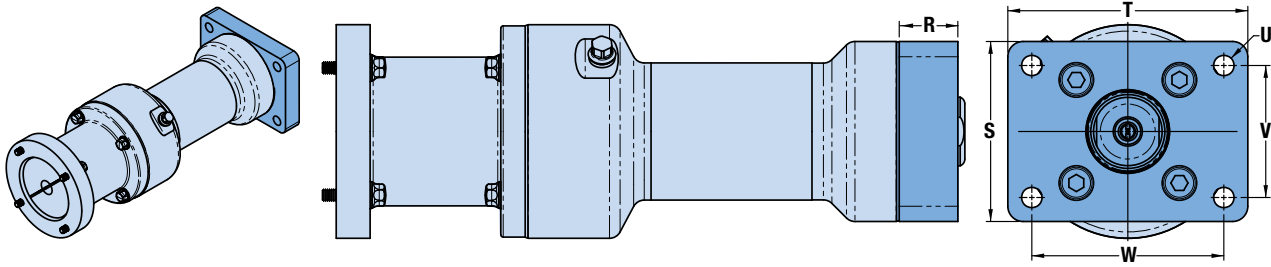

	R	S	T	U	V	W
RSH22	0.98	2.95	3.88	0.34	2.00	3.00
RSH25	1.16	4.75	6.25	0.42	3.32	5.44
RSH30	1.20	4.75	6.25	0.49	3.32	5.44

Dimensions in inches

	R	S	T	U	V	W
RSH22	25.0	75.0	98.6	8.5	50.8	76.2
RSH25	29.5	120.7	158.8	10.7	84.3	138.2
RSH30	30.5	120.7	158.8	12.5	84.3	138.2

Dimensions in millimeters

FM2 - FOOT MOUNT OPTION

FRONT MOUNT ORIENTATION

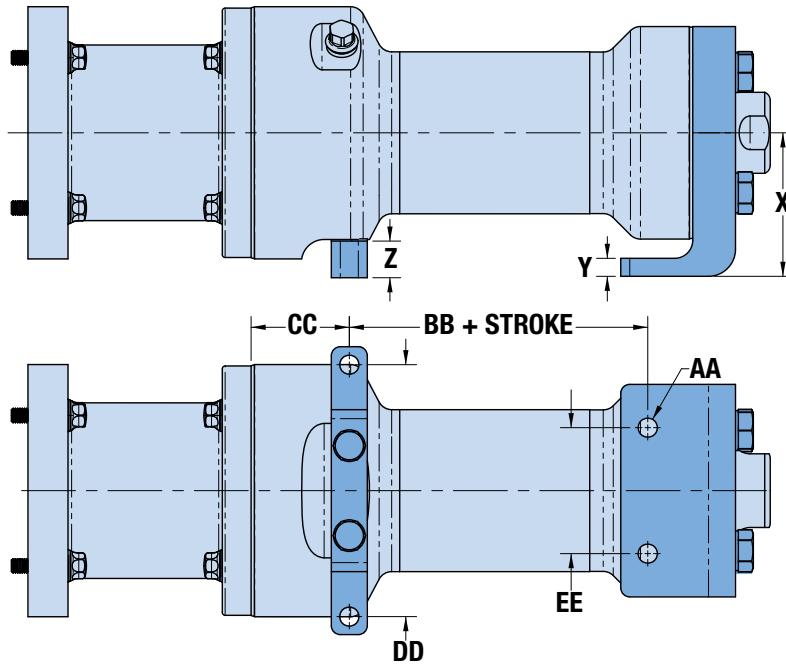
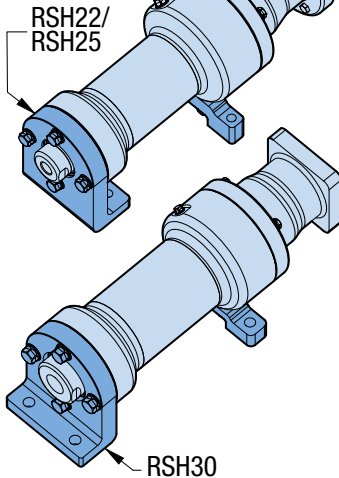

	X	Y	Z	Ø AA	BB	CC	DD	EE
RSH22	2.52	.38	.83	.28	4.31	1.29	3.50	1.75
RSH25	3.15	.50	.79	.47	6.06	1.52	4.75	2.75
RSH30	3.15	.63	.79	.47	9.41	1.52	4.75	2.75

Dimensions in inches

	X	Y	Z	Ø AA	BB	CC	DD	EE
RSH22	64.0	9.5	21.0	7.1	109.5	32.9	88.9	44.5
RSH25	79.9	12.7	20.0	12.0	154.0	38.6	120.7	69.9
RSH30	79.9	15.9	20.0	12.0	239.0	38.6	120.7	69.9

Dimensions in millimeters



tolomatic.com/ask
 Technical support
 before and after
 purchase

RSH – Hygienic Electric Rod-Style Actuator



tolomatic.com/CAD
Download 3D CAD
Always use CAD solid model to
determine critical dimensions

SIZE: 22, 25, 30

DIMENSIONS

TRR/TRM - TRUNNION MOUNT OPTION

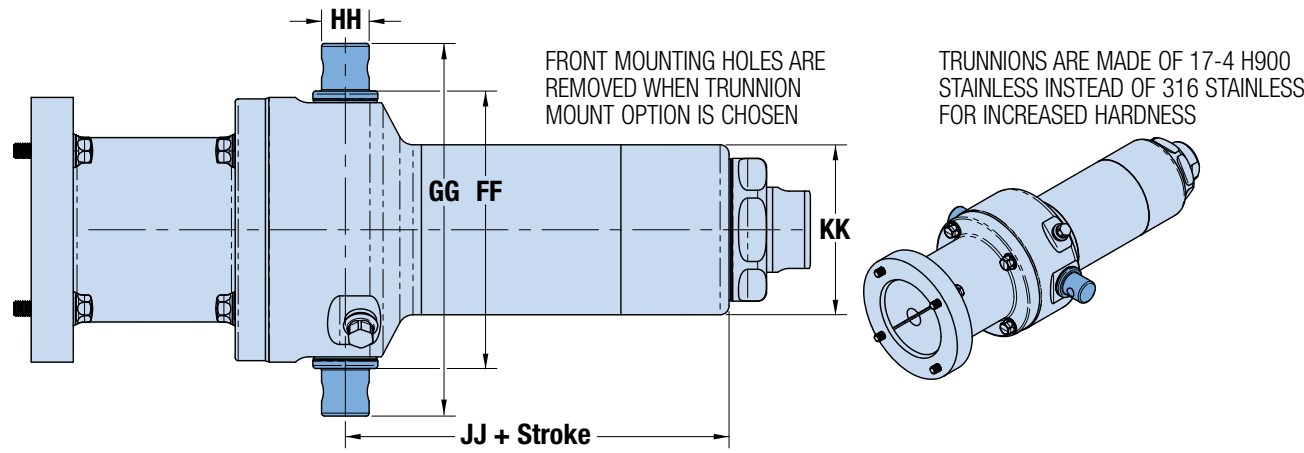

TRR	FF	GG	Ø HH	JJ	KK
RSH22	3.67	4.93	0.625	0.624	5.20
RSH25	5.05	7.17	1.000	0.999	7.05
RSH30	5.05	7.17	1.000	0.999	8.07

Dimensions in inches

TRM	FF	GG	Ø HH	JJ	KK
RSH22	93.3	125.3	16.00	15.97	132.0
RSH25	128.3	182.1	25.00	24.98	179.0
RSH30	128.3	182.1	25.00	24.98	205.0

Dimensions in millimeters

RSH TO ERD MOUNT OPTION

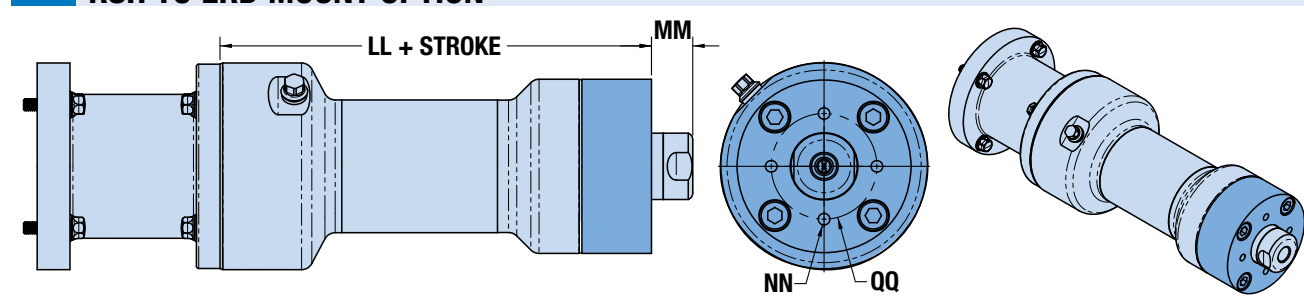

	LL	MM	NN	Ø QQ
RSH22	7.32	0.70	M6x1.0 x \downarrow 0.47	1.791
RSH25	9.34	0.94	M8x1.25 x \downarrow 0.63	3.000
RSH30	10.74	0.94	M8x1.25 x \downarrow 0.63	3.000

Dimensions in inches

	LL	MM	NN	Ø QQ
RSH22	185.8	17.8	M6x1.0 x \downarrow 12.0	45.50
RSH25	237.2	17.8	M8x1.25 x \downarrow 16.0	76.20
RSH30	272.7	23.9	M8x1.25 x \downarrow 16.0	76.20

Dimensions in millimeters

MET/IET - EXTERNALLY THREADED ROD END OPTION

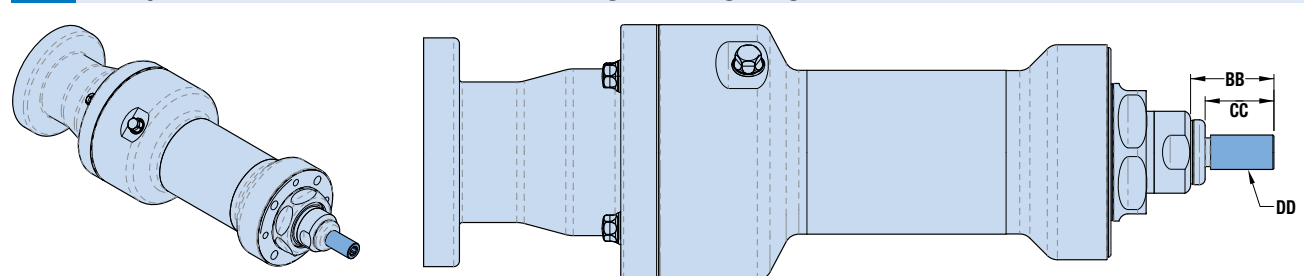

IET	BB	CC	DD
RSH22	1.20	1.000	1/2-20
RSH25	1.70	1.500	3/4-16
RSH30	2.30	2.000	1-14

Dimensions in inches

MET	BB	CC	DD
RSH22	29.1	24.00	M12x1.25
RSH25	49.5	44.45	M20x1.5
RSH30	58.4	50.80	M27x2.0

Dimensions in millimeters

RSH – Hygienic Electric Rod-Style Actuator



SWITCHES

SPECIFICATIONS



RSH actuators have 6 switch options: reed, solid state PNP (sourcing) or solid state NPN (sinking); normally open; with flying leads or quick-disconnect.

Commonly used for end-of-stroke positioning, these switches allow clamp-on installation anywhere along the entire actuator length. The internal magnet, located on the thrust tube, is a standard feature. Switches can be installed in the field at any time.

Switches are used to send digital signals to PLC (programmable logic controller), TTL, CMOS circuit or other controller device. Switches contain reverse polarity protection. Solid state QD cables are shielded; shield should be terminated at flying lead end.

All switches are CE rated, IP67 rated and are RoHS compliant. Switches feature bright red or green LED signal indicators.



	Order Code	Part Number	Lead	Switching Logic	Power LED	Signal LED	Operating Voltage	**Power Rating (Watts)	Switching Current (mA max.)	Current Consumption	Voltage Drop	Leakage Current	Temp. Range	Shock / Vibration	IP Rating
REED	R Y	2190-9082	5m	SPST Normally Open	—	Red	5 - 240 AC/DC	**10.0	100mA	—	3.0 V max.	—	14 to 158°F	30 G / 9 G	67
	R K	2190-9083	QD*												
SOLID STATE	T Y	2190-9088	5m	PNP (Sourcing) Normally Open	—	Green	5 - 30 VDC	**3.0	200mA	8 mA @ 24V	1.0 V max.	0.01 mA max.	[-10 to 70°C]	50 G / 9 G	
	T K	2190-9089	QD*												
	K Y	2190-9090	5m	NPN (Sinking) Normally Open	—	Red									
	K K	2190-9091	QD*												

*QD = Quick-disconnect Enclosure classification IEC 529 IP67 (NEMA 4) CABLES: Robotic grade, oil resistant polyurethane jacket, PVC insulation

⚠️ **WARNING: Do not exceed power rating (Watt = Voltage x Amperage). Permanent damage to sensor will occur.

SWITCH INSTALLATION - FIELD REPLACEMENT INSTRUCTIONS



STEP 1:
Loosen screw and nut.



STEP 2:
Place sensor and wrap the band around the RSH cylinder. Position the hook with the nearest hole on the band and mark the hole with a permanent marker.

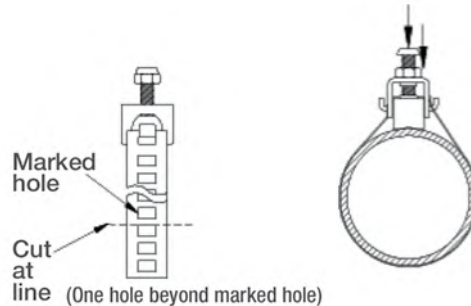

STEP 3:
Remove mounting assembly. Cut the band at the nearest edge of the next hole. (The one that's furthest away from the mounting head.)



STEP 4:
Replace the sensor and mounting assembly. Wrap the band and put the chosen hole on the hook. Position the switch and tighten. Tighten nut for steadying.

RSH – Hygienic Rod-Style Actuator



SWITCHES

WIRING DIAGRAMS

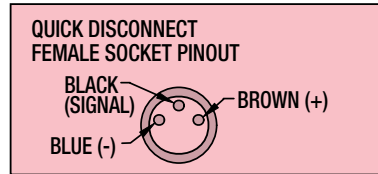
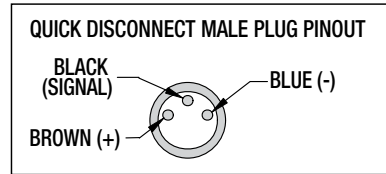
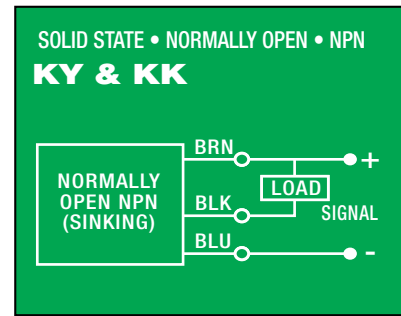
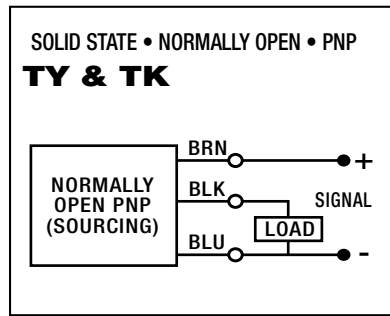
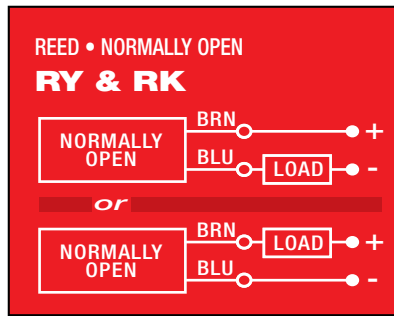

SWITCH DIMENSIONS

Y - direct connect

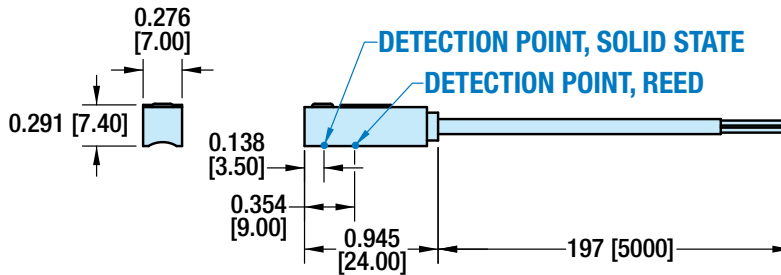

K - QD (Quick-disconnect) switch

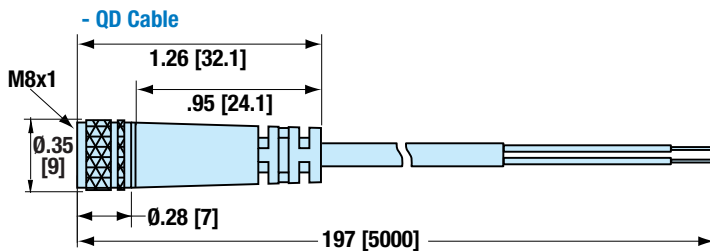

SWITCH CLAMP

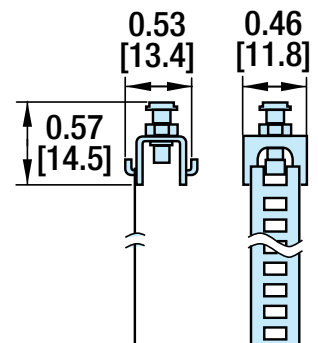

APPLICATION DATA WORKSHEET

Fill in known data. Not all information is required for all applications

ORIENTATION

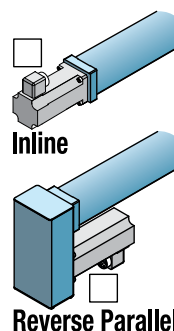
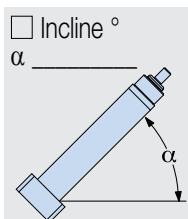
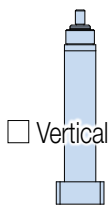
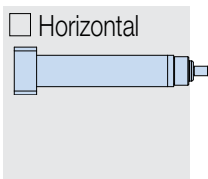

Load supported by actuator OR Load supported by other mechanism

MOVE PROFILE

EXTEND

Move Distance _____

inch (US conventional) millimeters (Metric)

Move Time _____ sec

Max. Speed _____

in/sec mm/sec

Dwell Time After Move _____ sec

STROKE LENGTH

inch (US conventional) millimeters (Metric)

PRECISION

Repeatability _____
 inch millimeters

RETRACT

Move Distance _____

inch millimeters

Move Time _____ sec

Max. Speed _____

in/sec mm/sec

Dwell Time After Move _____ sec

OPERATING ENVIRONMENT

Temperature, Contamination, Water, etc.

NO. OF CYCLES

per minute per hour

HOLD POSITION?

Required

Not Required

After Move During Power Loss

NOTE: If load or force changes during cycle use the highest numbers for calculations

MOTION PROFILE

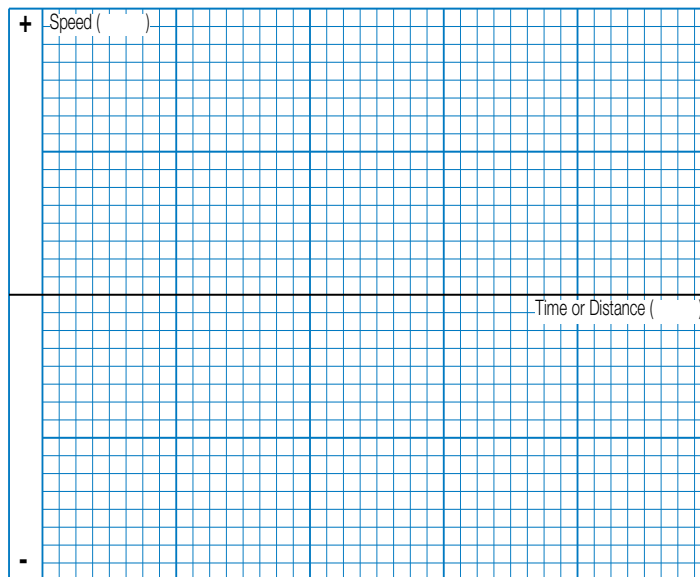

Graph your most demanding cycle, including accel/decel, velocity and dwell times. You may also want to indicate load variations and I/O changes during the cycle. Label axes with proper scale and units.

EXTEND

LOAD

lb. (U.S. Standard) kg. (Metric)

FORCE

lbf. (U.S. Standard) N (Metric)

RETRACT

LOAD

lb. (U.S. Standard) kg. (Metric)

FORCE

lbf. (U.S. Standard) N (Metric)

CONTACT INFORMATION

Name, Phone, Email _____
Co. Name, Etc. _____



USE THE TOLONATIC SIZING AND SELECTION SOFTWARE AVAILABLE ONLINE AT www.tolomatic.com OR... CALL TOLONATIC AT 1-800-328-2174.

We will provide any assistance needed to determine the proper actuator for the job.

FAX 1-763-478-8080

EMAIL help@tolomatic.com

RSH – Hygienic Rod-Style Actuator



Selection Guidelines

1 ESTABLISH MOTION PROFILE

Using the application stroke length, desired cycle time, loads and forces, establish the motion profile details including linear velocity and thrust in each of its segments.

2 SELECT ACTUATOR SIZE AND SCREW TYPE

Based on the required velocities and thrust select a size and screw type and lead of the RSH actuator.

3 VERIFY CRITICAL SPEED OF THE SCREW

Verify that the application's peak linear velocity does not exceed the critical speed value for the size and lead of the screw selected.

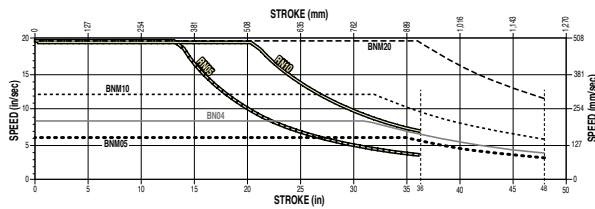

4 VERIFY AXIAL BUCKLING STRENGTH OF THE SCREW

Verify that the peak thrust does not exceed the critical buckling force for the size of the screw selected.

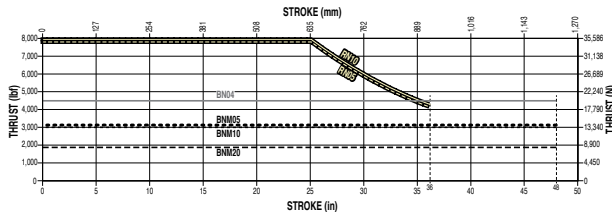

5 ESTABLISH TOTAL TORQUE REQUIREMENTS

Calculate total system inertia. The peak and RMS torque required from the motor to overcome internal friction, external forces and accelerate/decelerate the load.

6 CALCULATE LIFE

Determine the practical load of the system to calculate the L10 estimated life.

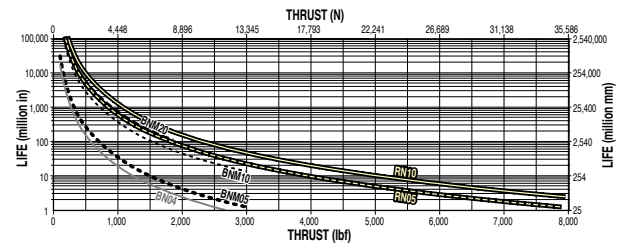

7 SELECT MOUNTING AND SENSOR CHOICES

Mounting options include: **T|R|R** trunnion mount, **F|F|G** front flange mount, **F|M|2** foot mount. 6 sensor choices include: reed, solid state PNP and solid state NPN, with either flying lead cables or the quick-disconnect cable option. All sensors are normally open.



RSH – Hygienic Electric Rod-Style Actuator

SERVICE PARTS ORDERING

RSH ACTUATOR REPLACEMENT KITS

Code	Description	RSH SIZE		
		22	25	30
FFG	Front Flange Mount Kit	2122-9020	2125-9020	2130-9020
FM2	* Foot Mount Kit	2122-9021	2125-9021	2130-9021
TRR	*† Trunnion Mount	2122-1042	2125-1042	2125-1042
TRM	*† Trunnion Mount	2122-1041	2125-1041	2125-1041
ERD	RSH to ERD Face Mount Adapter	2122-9019	2125-9019	2130-9019
IET	Imperial Male Thread Adapter	2122-9036	2125-9036	2130-9036
MET	Metric Male Thread Adapter	2122-9035	2125-9035	2130-9035
PSL	Standard Rod Seal Kit	2122-9009	2125-9009	2130-9009
USL	FDA Rod Seal Kit	2122-9010	2125-9010	2130-9010

* REPLACEMENT ONLY

† Quantity 1, Trunnion Mount; for pair order 2

RSH SWITCHES

To order switch kits use configuration code for switch preceded by SW and actuator code.

EXAMPLE: **SWRSH25KK**

KIT	ACTUATOR	SIZE	SWITCH CODE
S	R	25	KK

The example is for a Solid State NPN, Normally Open switch with Quick-disconnect Coupler. The Switch Kit is complete with Bracket, Set Screw, Switch and mating QD cable.

Code	Lead	Normally	Sensor Type
R Y	5m (197 in)	Open	Reed
R K	Quick-disconnect		
T Y	5m (197 in)	Open	Solid State PNP
T K	Quick-disconnect		
K Y	5m (197 in)	Open	Solid State NPN
K K	Quick-disconnect		



tolomatic.com/ask
**Technical support
before and after
purchase**

RSH – Hygienic Electric Rod-Style Actuator

ORDERING

RSH 25 RN05 SM152-4 LMI PSL

MODEL	
RSH	Rod-Style Actuator

SIZE	
22, 25, 30	

NUT/SCREW COMBINATIONS

SIZE	CODE	revs/in or lead
22	BNM	05, 10, 20 mm lead
	RN	05, 10 mm lead
25	BN	04 rev/in
	BNM	05, 10, 25 mm lead
	RN	05, 10 mm lead
30	BN	04 rev/in
	BNM	05, 10, 20mm lead
	RN	05, 10 mm lead

STROKE LENGTH

SM__ Enter desired stroke length in millimeters (25.4mm = 1 inch)

SIZE	MAXIMUM STROKE			
	SN or BN		Roller Nut	
	mm	in	mm	in
22	1000.0	39.4	609.6	24
25	1000.0	39.4	914.4	36
30	1219.2	48.0	914.4 [§]	36 [§]

Contact Tolomatic with requests for longer strokes

[§] RSH30 extended stroke length 50" (1270mm) available for roller screws, contact Tolomatic for production time.

Not all codes listed are compatible with all options. Contact Tolomatic with any questions.



tolomatic.com/CAD
Download 3D CAD
Always use CAD solid model to determine critical dimensions



tolomatic.com/yhm
YOUR MOTOR HERE
Motor Mounts
Made-to-Order



sizeit.tolomatic.com
for fast, accurate actuator selection



tolomatic.com/ask
Technical support
before and after purchase

Available FREE at www.tolomatic.com

OPTION ORDERING

ARI FFG KK2 YM

MOTOR MOUNTING	
LMI	In-line motor mount
RP1	1:1 ratio, Reverse Parallel motor mount
RP2	2:1 ratio, Reverse Parallel motor mount

SEALING OPTIONS	
PSL	Polyurethane/Polyurethane Rod Seals (Standard)
USL	Polyurethane/UHMWPE Rod Seals (Severe Chemicals)

ACTUATOR GUIDE & ANTI-ROTATE	
ARI	Internal Anti-Rotate
✗	ARI not available for RSH30 RN05, RSH30 RN10

ROD END OPTION	
IET	Imperial External (Male) Thread Adapter
MET	Metric External (Male) Thread Adapter

ACTUATOR MOUNTING	
FFG	Front Flange Mount
TRM	Trunnion Mounting, Rear (metric)
TRR	Trunnion Mounting, Rear (US standard)
FM2	Foot Mount
ERD	RSH to ERD Face Mount Adapter

SWITCHES**						
TYPE	LOGIC	NORMALLY	QUICK-DISCONNECT	CODE	QUANTITY	LEAD LENGTH
REED	SPST	Open	No	RY	After code enter quantity desired	5 m (16.4 feet)
			Yes	RK		
SOLID STATE	PNP	Open	No	TY	5 m (16.4 feet)	6 in (152mm) to QD connector w/ 5m lead
			Yes	TK		
	NPN	Open	No	KY		
			Yes	KK		

**NOTE: Switches are shipped together with the actuator but are not installed by Tolomatic.

YOUR MOTOR HERE	
YM	Motor mount for non-Tolomatic motor. www.tolomatic.com

NOTE: Brakes mounted on reverse parallel motor mounts (especially in vertically positioned actuators) will not prevent back driving of the screw and the load falling under gravity in the event of a timing belt failure. An inline motor mount with a fail-safe brake mounted directly to the actuator shaft or a special geared or thru-shaft reverse parallel construction should be considered if a brake is required in a safety critical application. Contact Tolomatic for alternate reverse parallel brake mounting options.

Gearheads may be used with reverse parallel motor mounts. However, the torque on the belt and internal RP components must remain below the capabilities of the assembly to prevent belt slipping or premature failure. Contact Tolomatic for additional information if required.

The Tolomatic Difference Expect More From the Industry Leader:



INNOVATIVE PRODUCTS

Solutions with Endurance TechnologySM for challenging applications.



FAST DELIVERY

Built-to-order with configurable stroke lengths and flexible mounting options.

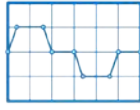

ACTUATOR SIZING

Size and select electric actuators with our online software.



YOUR MOTOR HERE[®]

Match your motor to compatible mounting plates with Tolomatic actuators.



CAD LIBRARY

Download 2D or 3D CAD files for Tolomatic products.



TECHNICAL SUPPORT

Get a question answered or request a virtual design consultation with one of our engineers.

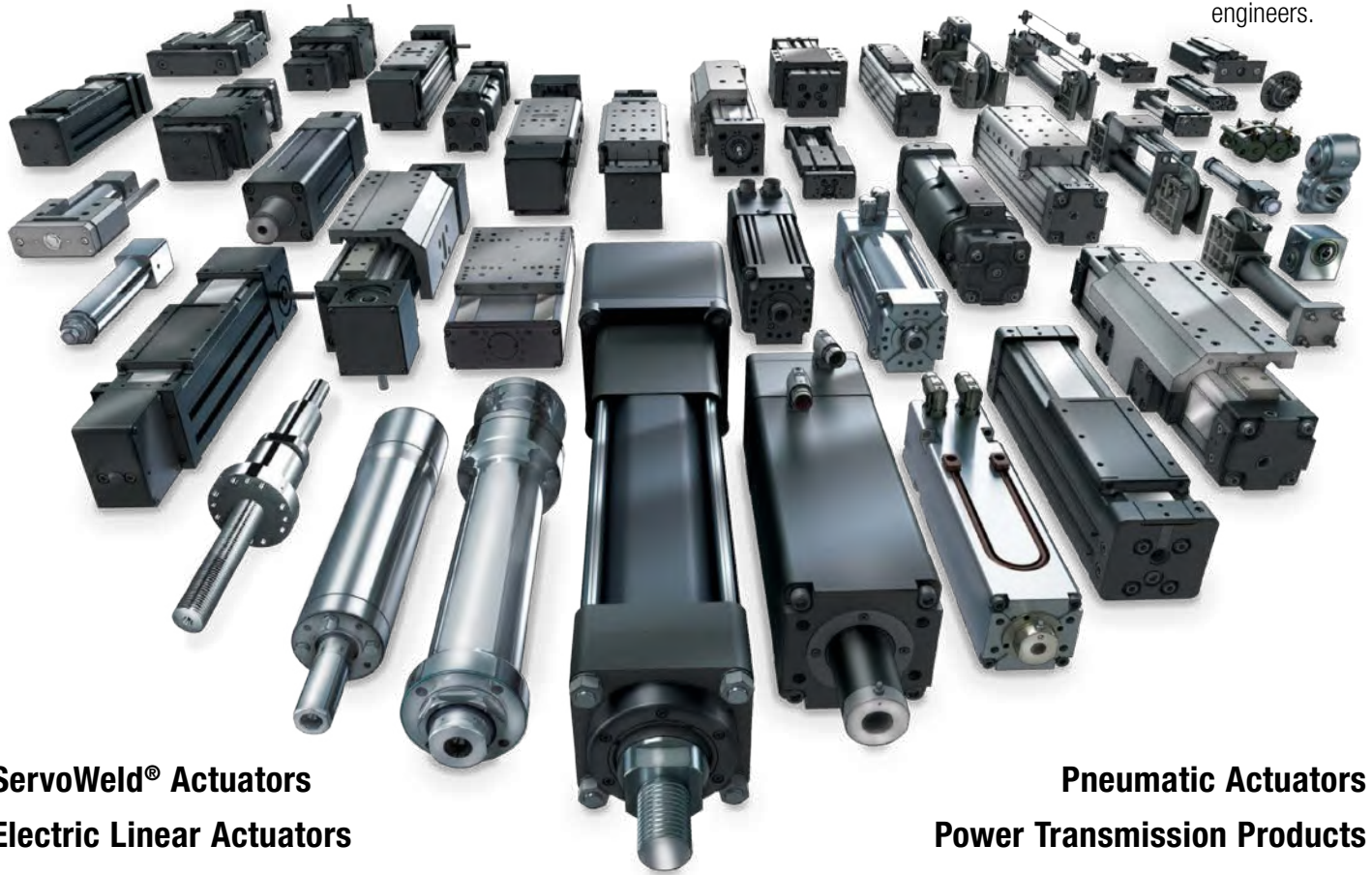

ServoWeld[®] Actuators
Electric Linear Actuators

Pneumatic Actuators
Power Transmission Products



MADE IN U.S.A.

TolomaticTM

EXCELLENCE *IN MOTION*

COMPANY WITH
QUALITY SYSTEM
CERTIFIED BY DNV
= ISO 9001 =
Certified site: Hamel, MN

USA - Headquarters

Tolomatic Inc.
3800 County Road 116
Hamel, MN 55340, USA
Phone: (763) 478-8000
Toll-Free: **1-800-328-2174**
sales@tolomatic.com
www.tolomatic.com

MEXICO

Centro de Servicio
Parque Tecnológico Innovación
Int. 23, Lateral Estatal 431,
Santiago de Querétaro,
El Marqués, México, C.P. 76246
Phone: +1 (763) 478-8000
help@tolomatic.com

EUROPE

Tolomatic Europe GmbH
Elisabethenstr. 20
65428 Rüsselsheim
Germany
Phone: +49 6142 17604-0
help@tolomatic.eu
www.tolomatic.com/de-de

CHINA

**Tolomatic Automation Products
(Suzhou) Co. Ltd.**
No. 60 Chuangye Street, Building 2
Huqiu District, SND Suzhou
Jiangsu 215011 - P.R. China
Phone: +86 (512) 6750-8506
Tolomatic_China@tolomatic.com

All brand and product names are trademarks or registered trademarks of their respective owners. Information in this document is believed accurate at time of printing. However, Tolomatic assumes no responsibility for its use or for any errors

that may appear in this document. Tolomatic reserves the right to change the design or operation of the equipment described herein and any associated motion products without notice. Information in this document is subject to change without notice.

Visit www.tolomatic.com for the most up-to-date technical information