

RSA & GSA ELECTRIC ROD-STYLE ACTUATORS

ENDURANCE TECHNOLOGYSM
A Tolomatic Design Principle



LINEAR SOLUTIONS MADE EASY

RSA & GSA Electric Rod-Style Actuators

WHAT ARE THE RSA & THE GSA?

The RSA is a flexible electric screw driven rod-style actuator. The standard RSA-ST model comes in six sizes. The guided RSA (GSA) adds guidance and load support to the design and is available in the 4 smaller sizes. The high force RSA-HT model is available in the 4 larger sizes, it incorporates stronger torque transmission components (couplers, pulleys, belts) and higher capacity thrust bearings.



**Fast Delivery
Built-to-Order**

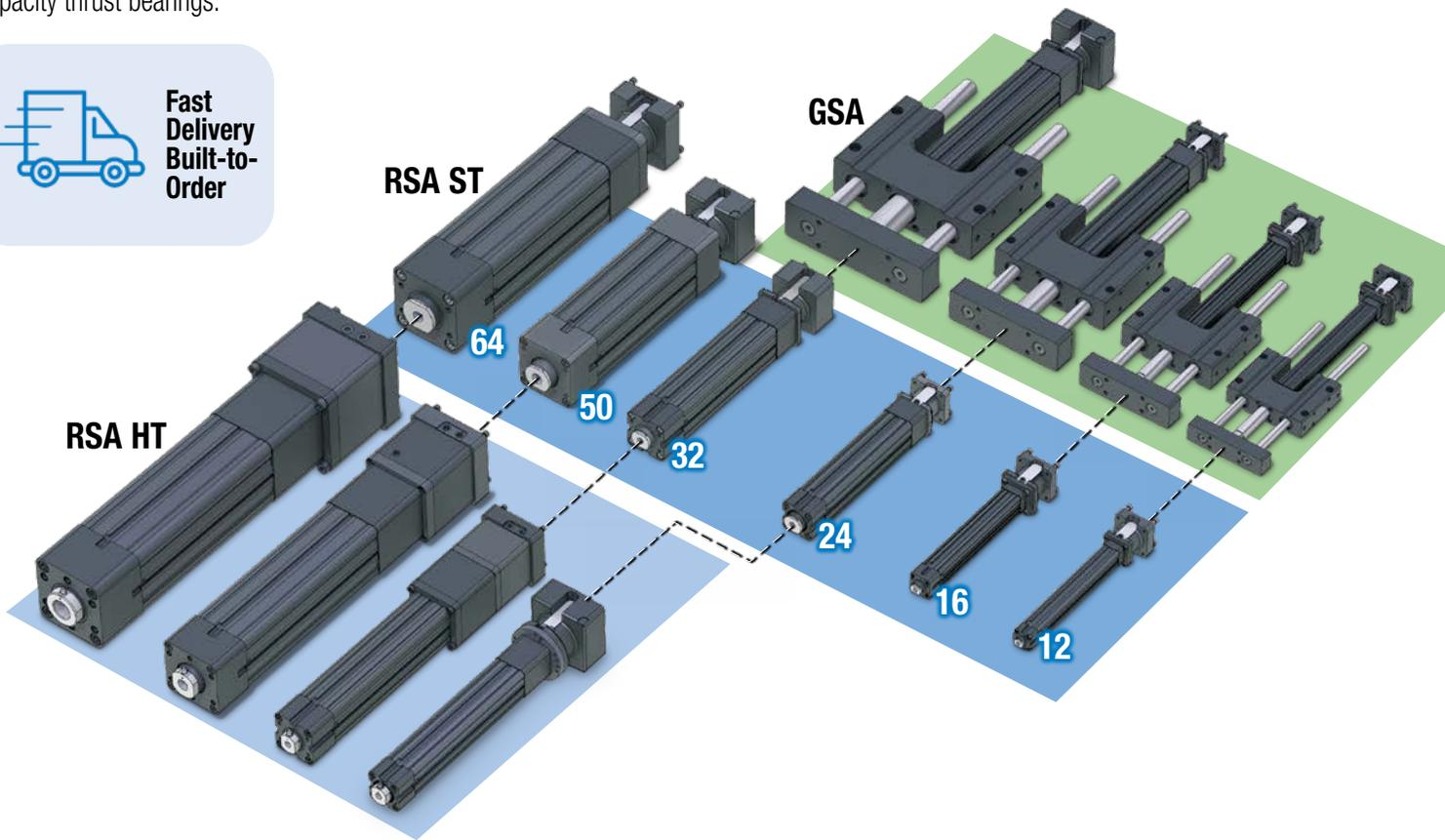

TOLOMATIC'S ELECTRIC ROD-STYLE ACTUATORS

	ERD	RSH	RSA	RSX	GSA	IMA
						
	Rod-Style Actuator	Hygienic Rod-Style Actuator	Rod-Style Actuator	Rod-Style Actuator	Guided Rod-Style Actuator	Integrated Servo Actuator
Force up to:	2.2 kN (500 lbf)	35 kN (7,943 lbf)	58 kN (13,039 lbf)	294 kN (66,000 lbf)	4.2 kN (950 lbf)	35.8 kN (8,044 lbf)
Speed up to:	1,016 mm/sec (40 in/sec)	498 mm/sec (19.6 in/sec)	3,124 mm/sec (123 in/sec)	760 mm/sec (29.9 in/sec)	3,124 mm/sec (123 in/sec)	1,334 mm/sec (52.5 in/sec)
Stroke Length up to:	609 mm (24 in)	1,219 mm (48 in)	1,524 mm (60 in)	1,500 mm (59 in)	914 mm (36 in)	457 mm (18 in)
Screw/Nut Type	Solid & Ball	Ball & Roller	Solid, Ball & Roller	Ball & Roller	Solid & Ball	Ball & Roller
<i>For complete information see www.tolomatic.com or literature number:</i>						
Literature Number:	2190-4000	2100-4010	3600-4166	2171-4001	3600-4166	2700-4000

(Not all models deliver maximum values listed, i.e.: Maximum thrust may not be available with maximum speed)

RSA & GSA Electric Rod-Style Actuators

Applications

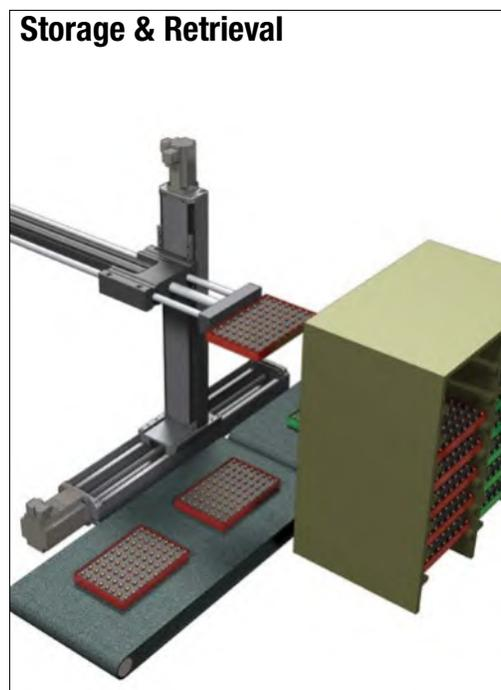
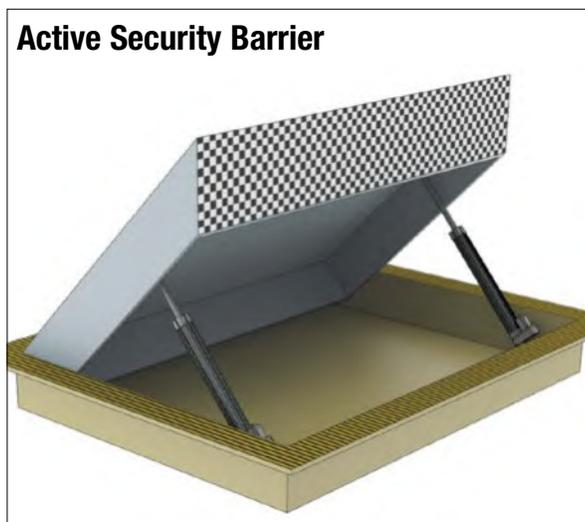
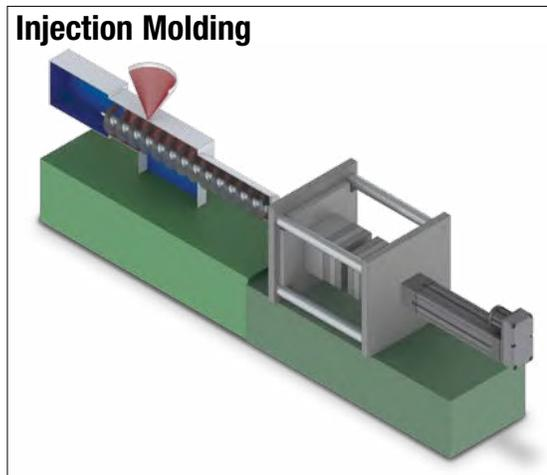
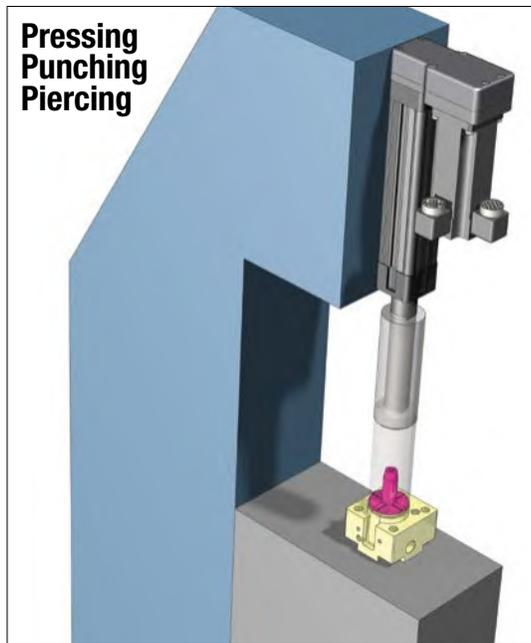

Other Applications:

- Animation
- Assembly machinery
- Automatic tool changers
- Automotive
- Clamping
- Converting
- Conveyors
- Cycle testing
- Fillers
- Formers
- Hydraulic replacement
- Laser positioning
- Machine tools
- Material handling
- Medical equipment
- Molding
- Motion simulators
- Open / close doors
- Packaging equipment
- Parts clamping
- Patient lifts
- Pick & place
- Pneumatic replacement
- Precision grinders
- Product test simulations
- Riveting / fastening / joining
- Robot manipulator arms
- Sawmill equipment
- Semiconductor
- Stage motion control
- Stamping
- Table positioning
- Tension control
- Test stands
- Tube bending
- Volumetric pumps
- Water jet control
- Wave generation
- Web guidance
- Welding
- Wire winding
- and many more

CONTENTS

What are RSA & GSA	R/GSA_2
Rod-Style Actuators	R/GSA_2
Applications	R/GSA_3
RSA ST Features	R/GSA_4
RSA HT Features	R/GSA_6
RSA Options	R/GSA_6
GSA Features	R/GSA_8
RSA ST	R/GSA_10
Specifications	R/GSA_10
Performance	R/GSA_12
Specifications	R/GSA_18
Dimensions	R/GSA_18
Option Dimensions	R/GSA_20
RSA HT	R/GSA_28
Specifications	R/GSA_28
Performance	R/GSA_30
Specifications	R/GSA_34
Dimensions	R/GSA_36
Option Dimensions	R/GSA_38
GSA	R/GSA_44
Specifications	R/GSA_44
Performance	R/GSA_48
Specifications	R/GSA_44
Guide Rod Deflection	R/GSA_52
Dimensions	R/GSA_57
Option Dimensions	R/GSA_58
SWITCHES	R/GSA_59
Appl. Data Worksheet	R/GSA_61
Selection Guidelines	R/GSA_62
Service Parts Ordering	R/GSA_63
RSA ORDERING	R/GSA_64
GSA ORDERING	R/GSA_65
Tolomatic Difference	R/GSA_66

RSA-ST ROD-STYLE ACTUATOR

ENDURANCE TECHNOLOGYSM

A Tolomatic Design Principle

Endurance Technology features are designed for maximum durability to provide extended service life.

The RSA rod screw actuator is ideal for medium to high thrust applications of guided loads. The compact design and cylinder style operation make this solution ideal for applications that were historically solved with pneumatic or hydraulic power. Many mounting options are available allowing the actuator to be installed in numerous applications. Built-to-order in stroke lengths up to 60 in (1.5 m) with your choice of screw technology.

RSA-ST

HIGH POSITIONAL ACCURACY

SCREW ACCURACY

Roller Nut ± 0.0004 "/ft.	± 0.0102 mm/300mm
Metric Ball Nut ± 0.002 "/ft.	± 0.051 mm/300mm

MULTIPLE SCREW TECHNOLOGIES

YOU CAN CHOOSE:

- Solid nuts of bronze or engineered resins offer quiet performance at the lowest cost; anti-backlash available
- Ball nuts offer efficiency at a cost effective price; low-backlash available



THRUST TUBE

- Steel thrust tube supports extremely high force capabilities
- Salt bath nitride treatment provides excellent corrosion resistance, surface hardness and is very resistant to adherence of potential contaminants

INTERNAL BUMPERS

Bumpers protect the screw and nut assembly from damage at both ends of stroke

SCREW SUPPORT BEARING

Engineered resin bearing provides continuous support of screw

NOSE BEARING

- Support the thrust tube and nut assembly through entire stroke length
- Unique nose bearing material allows for smooth operation and support of the thrust rod

THREADED ROD END

Provides a common interface to multiple rod end options

ROD WIPER

Prevents contaminants from entering the housing for extended life of the actuator

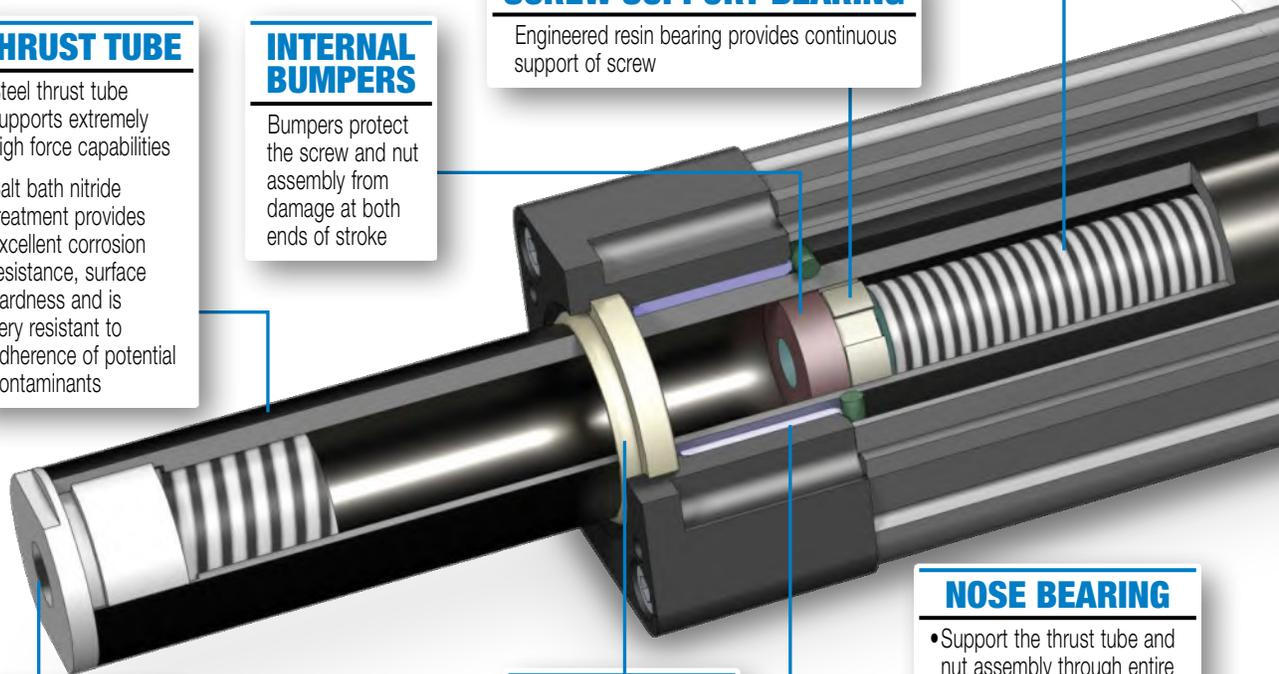

YOUR MOTOR HERE

YOU CAN CHOOSE:

- Specify the device to be installed and actuator ships with proper mounting hardware
- Specify and ship your device to Tolomatic for factory installation
- Motor supplied and installed by Tolomatic

MOTOR ORIENTATION

YOU CAN CHOOSE:

- Inline option directly couples the driving shaft and is typically a one-piece housing construction for optimum alignment and support of the motor
- Reverse-parallel option minimizes the overall length, coupling motor and driving shaft via a belt with a 1:1 or 2:1 reduction ratio

HIGH THRUST BEARING

Unique high thrust bearing assembly design eliminates run-out and isolates the linear forces for the drive shaft

BREATHER/PURGE PORTS



- Standard feature on RSA 32,50,64 size actuators
- As seen in this view, located on both the bottom and the opposite side of the actuator

• Use as Breather Port: allows air flow into the interior of the actuator. Prevents additional load on the motor caused by air buildup due to fast cycling of the RSA.

Use as Purge Port: positive pressure with air lines and filters insure contaminants (which could potentially shorten the actuator life) do not enter the interior of the actuator.

LIGHTWEIGHT ALUMINUM DESIGN

- Black anodized extrusion design is optimized for rigidity and strength
- External switch channels on all sides allow easy placement of position indicating switches

INTERNAL NUT BEARINGS

- Engineered resin guide bearings provide anti-rotation of the thrust rod
- Support the thrust tube and nut assembly through entire stroke length



OPTIONS

See page 7 for a complete list of RSA options including the HT-high torque option

RSA-HT OPTION

ENDURANCE TECHNOLOGYSM

A Tolomatic Design Principle

The HT option is a higher thrust option for the 24, 32, 50 and 64 sizes of the RSA family. RSA actuators with roller nuts are always HT option actuators. Use Tolomatic's online sizing software to determine if the HT Option is right for your application

STANDARD FEATURES
See page 4 for a complete list of RSA standard features

REDESIGNED LMI & RP HOUSING

Specially designed to accommodate larger motors & gearboxes with higher torques and larger bolt circles (up to 6.5", 165mm)

DURABLE BELT MATERIAL

High torque polyurethane timing belt with carbon tensile cords resists stretching

ENHANCED HIGH THRUST BEARING

RSA HT actuators come with high thrust angular contact ball bearing in matched pair assembly design which eliminates run-out and isolates the linear forces from the drive shaft

MULTIPLE SCREW TECHNOLOGIES

YOU CAN CHOOSE:

- Bronze solid nuts offer quiet performance at the lowest cost; anti-backlash available
- Ball nuts offer efficiency at a cost effective price; low-backlash available
- Roller nuts provide the highest thrust and life ratings available (HT option)



HEAVY DUTY INTERNAL BUMPERS

Bumpers protect the screw and nut assembly from damage at both ends of stroke

WHY CHOOSE THE HT OPTION?

- Higher strength components transfer torque from the gearhead/motor through the actuator
- Grease zerk allows convenient relubrication for extended screw service life
- Accommodates mounting large motors with up to 165mm bolt circle pattern

YOUR MOTOR HERE (Standard Feature)

YOU CAN CHOOSE:

- Specify the device to be installed and actuator ships with proper mounting hardware
- Specify and ship your device to Tolomatic for factory installation
- Motor or gearbox supplied and installed by Tolomatic

IP67 OPTION

Resist water ingress 1m deep for up to 30 min

RSA-HT

OPTIONS (Available for all RSA actuators unless noted)

• METRIC OPTION

Provides metric tapped holes for mounting of load to rod end and of actuator to mating surfaces



• SWITCHES

Choose from: Reed, Solid State PNP or NPN, all available normally open or normally closed

• IP67

Static: special gaskets for basic protection against water and dust ingress
32,50,64 sizes only: HT actuator (LMI and RP); ST actuator (RP motor mount only)

ROD END



• MET: External Threads male threads

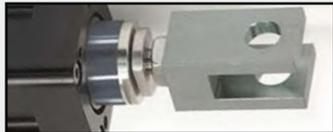

• CLV: Clevis Rod End for pivoting mount



• SRE: Spherical Rod End for pivoting mount



• ALC: Alignment Coupler Rod End to compensate for mounting alignment



• XR: Rod Extension to separate load from the actuator

MOUNTING



• MP2: Mounting Plates for surface mounting



• FFG: Front Flange for mounting near rod end



• TRR: Trunnion Mount for pivoting mount

Below are for RP Motor mounting only



• BFG: Rear Flange for mounting opposite the rod end



• PCD: Clevis
• PCS: Eye Mount for pivoting mount

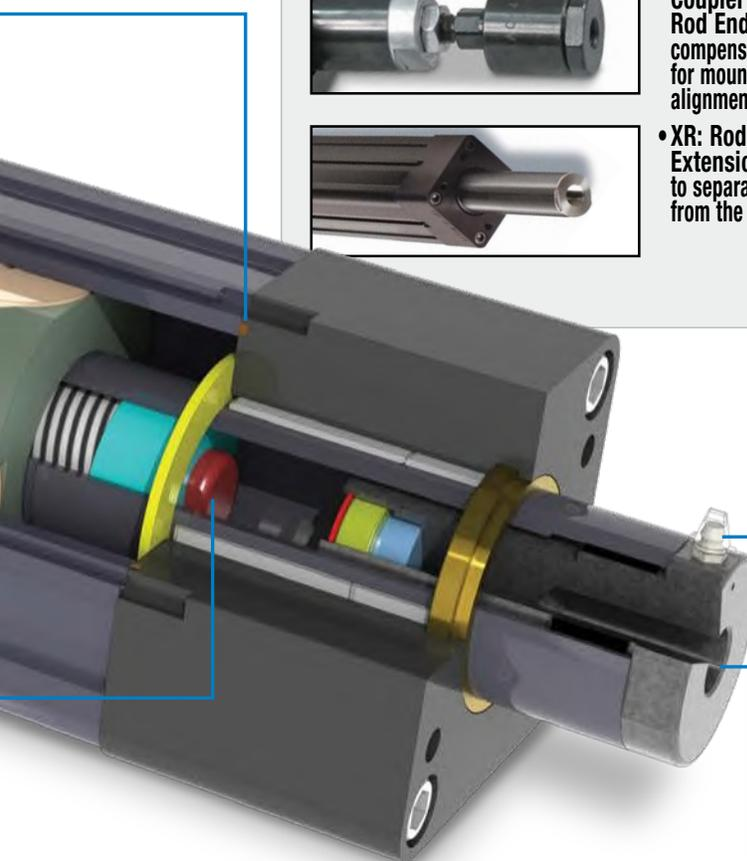

THREADED ROD END

Provides a common interface to multiple rod end options

GREASE ZERK

- This relubrication system provides extended screw service life
- Convenient lubrication without disassembly
- Standard with all HT option RSA actuators
- Grease zerk orientation is not pre-defined. Custom orientation can be requested as a product modification



GSA GUIDED ROD-STYLE ACTUATOR

ENDURANCE TECHNOLOGYSM

A Tolomatic Design Principle

Endurance Technology features are designed for maximum durability to provide extended service life.

The GSA guided screw actuator is ideal for medium thrust applications. The self-contained guided rod design and cylinder slide style operation make this solution ideal for applications requiring guidance and support of the load. A robust, wide tooling plate allows easy mounting of the required end effectors for many applications. Built-to-order in stroke lengths up to 36 in (914 mm) with your choice of screw technology.

MULTIPLE SCREW TECHNOLOGIES

YOU CAN CHOOSE:

- Solid nuts of bronze or engineered resins offer quiet performance at the lowest cost; anti-backlash available
- Ball nuts offer efficiency at a cost effective price; low-backlash available



ROD WIPER

Prevents contaminants from entering the housing for extended life of the actuator

LIGHTWEIGHT ALUMINUM DESIGN

- Black anodized bearing block provides solid structural support and multiple mounting options
- Black anodized tube extrusion design is optimized for rigidity and strength
- External switch channels on all sides allow easy placement of position indicating switches

ANODIZED ALUMINUM THRUST TUBE

- Lightweight design directly provides thrust with minimal additional inertia
- Corrosion resistant plating provides excellent protection from many chemicals

INTEGRAL GUIDE RODS AND BEARINGS

- Hardened steel guide rods provide high rigidity and low deflection
- Four composite or linear ball bearings support the load for smooth, consistent motion
- Lubrication wick supplies lube for life of actuator
- Oversized rods available for higher load capacity
- Stainless steel shafting option available for corrosion resistance

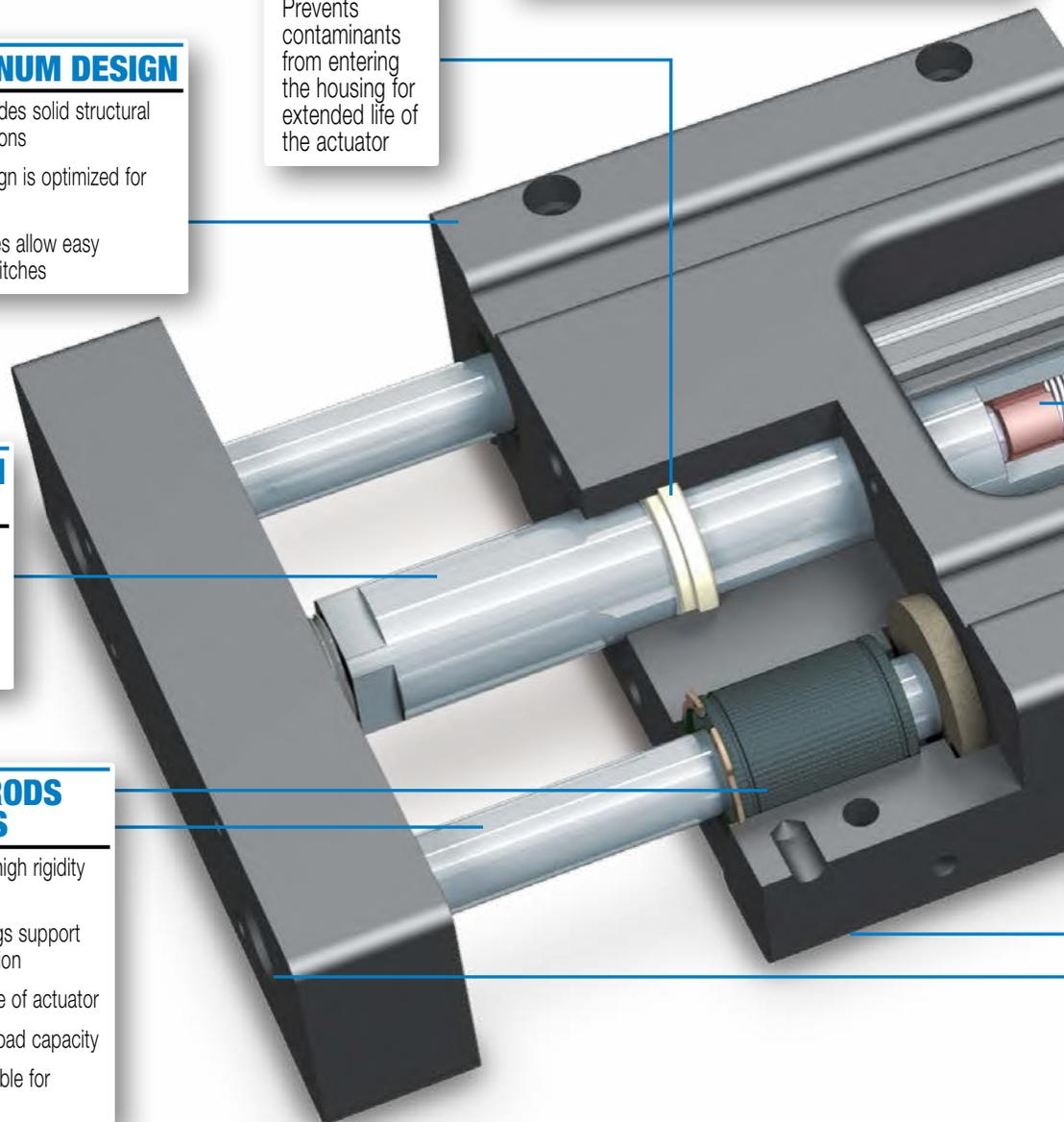

YOUR MOTOR HERE

YOU CAN CHOOSE:

- Specify the device to be installed and actuator ships with proper mounting hardware
- Specify and ship your device to Tolomatic for factory installation
- Motor supplied and installed by Tolomatic

MOTOR ORIENTATION

YOU CAN CHOOSE:

- Inline option directly couples the driving shaft and is typically a one-piece housing construction for optimum alignment and support of the motor
- Reverse-parallel option minimizes the overall length, coupling motor and driving shaft via a belt with a 1:1 or 2:1 reduction ratio

SCREW SUPPORT BEARINGS

- Unique high thrust bearing assembly design eliminates runout and isolates the linear forces for the drive shaft
- Engineered resin bearing provides continuous support of screw

PRECISION MACHINED SURFACES

- Extruded bearing housing is precision machined on two surfaces for true and easily aligned linear motion
- Tooling plate is aligned and assembled to provide a precise mounting surface

OPTIONS



• OVERSIZED GUIDE RODS

Available for increased load capacity or decreased deflection



• STOP COLLARS

Provide a positive stop mechanism when required



• CORROSION RESISTANCE

Includes 316 stainless steel guide rods and fasteners for better environmental protection



• METRIC OPTION

Provides metric tapped holes for mounting of load to tooling plate and of actuator to mating surfaces

• SWITCHES

Choose from: Reed, Solid State PNP or NPN, all available normally open or normally closed

RSA ST Electric Rod-Style Actuator

SIZE: ALL

units: US standard

SPECIFICATIONS



sizeit.tolomatic.com
for fast, accurate
actuator selection

RSA SIZE	MAX. STROKE in	SCREW CODE	TPI turns/in	LEAD ACCUR- ACY in/ft	BACK- LASH † in	MAX. THRUST* lbf	DYNAMIC LOAD RATING** lbf	BASE ACTUATOR INERTIA			INERTIA PER/in OF STROKE lb-in ²	DYNAMIC TORQUE TO OVERCOME FRICTION lb-in
								In Line lb-in ²	Reverse Parallel			
									1:1 lb-in ²	2:1 lb-in ²		
12	12	SN01	1.00	0.0100	0.0070	70	NA	0.004	0.005	NA	0.002	0.63
	12	SN02	2.00	0.0060	0.0070	70	NA	0.002	0.003	NA	0.001	0.56
	12	SN05	5.00	0.0060	0.0070	70	NA	0.002	0.002	NA	0.001	0.50
	12	BZ10	10.00	0.0060	0.0080	70	NA	0.002	0.002	NA	0.001	0.50
	12	BN(L)08	8.00	0.0030	0.0150	130	260	0.002	0.002	NA	0.001	0.50
16	18	SN01	1.00	0.0100	0.0070	70	NA	0.006	0.007	NA	0.002	1.31
	18	SN02	2.00	0.0060	0.0070	70	NA	0.003	0.003	NA	0.001	1.13
	18	SN05	5.00	0.0060	0.0070	70	NA	0.002	0.002	NA	0.001	1.06
	18	BZ10	10.00	0.0060	0.0080	70	NA	0.002	0.002	NA	0.001	1.06
	18	BN(L)08	8.00	0.0030	0.0150	130	260	0.002	0.002	NA	0.001	1.00
24	24	SN02	2.00	0.0050	0.0070	200	NA	0.116	0.117	0.071	0.005	1.81
	24	SN04	4.00	0.0100	0.0070	200	NA	0.116	0.117	0.071	0.004	1.69
	24	SN08	8.00	0.0100	0.0070	200	NA	0.116	0.117	0.071	0.004	1.63
	24	BZ10	10.00	0.0060	0.0080	603	NA	0.116	0.117	0.071	0.004	1.63
	24	BN(L)05	5.00	0.0030	0.0150	825	1,411	0.116	0.117	0.071	0.004	2.19
	24	BN(L)02	2.00	0.0030	0.0150	342	1,071	0.116	0.117	0.071	0.003	2.50
	24	BNM05	5.08	0.0040	0.0030	868	2,697	0.116	0.117	0.071	0.004	3.00
	24	BNM10	2.54	0.0040	0.0030	434	1,911	0.116	0.117	0.071	0.004	3.00
32	36	BZ10	10.00	0.0060	0.0080	785	NA	0.235	0.179	0.147	0.009	3.13
	36	BN(L)02	2.00	0.0040	0.0150	534	3,364	0.235	0.179	0.147	0.010	2.44
	36	BN(L)05	5.00	0.0030	0.0150	950	1,624	0.235	0.179	0.147	0.009	2.31
	36	BNM05	5.08	0.0040	0.0030	1357	3,080	0.235	0.179	0.147	0.010	5.60
	36	BNM10	2.54	0.0040	0.0030	678	4,721	0.235	0.179	0.147	0.010	5.60
	36	BNM20	1.27	0.0020	0.0050	339	2,560	0.235	0.179	0.147	0.011	5.60
50	48	BZ10	10.00	0.0060	0.0080	1,784	NA	0.654	1.104	0.458	0.035	4.13
	48	BN(L)01	1.00	0.0040	0.0150	758	2,300	0.654	1.104	0.458	0.035	4.13
	48	BN(L)02	2.00	0.0040	0.0150	1,517	5,355	0.654	1.104	0.458	0.029	3.63
	48	BN(L)04	4.00	0.0040	0.0150	3,034	5,159	0.654	1.104	0.458	0.028	4.25
	48	BNM05	5.08	0.0020	0.0040	2,347	4,035	0.654	1.104	0.458	0.026	7.50
	48	BNM10	2.54	0.0020	0.0040	1,926	3,372	0.654	1.104	0.458	0.026	7.50
	48	BNM25	1.02	0.0040	0.0050	771	2,537	0.654	1.104	0.458	0.026	7.50
64	60	BZ10	10.00	0.0060	0.0080	1,781	NA	2.306	2.461	2.316	0.139	5.44
	60	BN(L)53	0.53	0.0040	0.0150	538	5,961	2.306	2.461	2.316	0.180	14.70
	60	BN(L)02	2.00	0.0040	0.0150	2,019	11,402	2.306	2.461	2.316	0.142	5.31
	60	BN(L)04	4.00	0.0040	0.0150	4,028	6,746	2.306	2.461	2.316	0.140	5.38
	60	BNM05	5.08	0.0020	0.0040	2,033	6,714	2.306	2.461	2.316	0.170	9.40
	60	BNM10	2.54	0.0020	0.0040	2,033	7,476	2.306	2.461	2.316	0.170	9.40
	60	BNM20	1.27	0.0020	0.0050	1,282	5,528	2.306	2.461	2.316	0.170	9.40

SCREW CODE	DESCRIPTION
BN	Ball Nut
BNH	Ball Nut H-series
BNL	Low-Backlash Ball Nut
BNM	Ball Nut Metric
BZ	Bronze Nut
RN	Roller Nut
SN	Solid Nut



Contact Tolomatic for higher accuracy and lower backlash options.

† (L) for low backlash ball screws: backlash = 0.0020" (0.05 mm)

* For SN & BZ screws, maximum continuous dynamic thrust subject to Thrust x Velocity limitation.

** For RN, BN & BNL screws, dynamic load rating reflects 90% reliability for 1 million revolutions.

RSA-ST

RSA ST Electric Rod-Style Actuator



sizeit.tolomatic.com
for fast, accurate
actuator selection

SIZE: **ALL**

units: **metric****

SPECIFICATIONS

** RSA metric actuators use the same leadscrew as the RSA inch actuators. Threaded mounting and dowel pin holes are metric.

RSA SIZE	MAX. STROKE mm	SCREW CODE	LEAD mm/rev	LEAD ACCUR-ACY mm/300mm	BACK-LASH † mm	MAX. THRUST* N	DYNAMIC LOAD RATING** N	BASE ACTUATOR INERTIA			INERTIA PER/25mm OF STROKE kg-m ² x 10 ⁻⁶	DYNAMIC TORQUE TO OVERCOME FRICTION N-m
								In Line kg-m ² x 10 ⁻⁶	Reverse Parallel			
									1:1 kg-m ² x 10 ⁻⁶	2:1 kg-m ² x 10 ⁻⁶		
12	305	SN01	25.40	0.25	0.18	311	NA	1.171	1.463	NA	0.585	0.071
	305	SN02	12.70	0.15	0.18	311	NA	0.585	0.878	NA	0.293	0.064
	305	SN05	5.08	0.15	0.18	311	NA	0.585	0.585	NA	0.293	0.056
	305	BZ10	2.54	0.15	0.20	311	NA	0.585	0.585	NA	0.293	0.056
	305	BN(L)08	3.18	0.08	0.38	578	1,157	0.585	0.585	NA	0.293	0.056
16	457	SN01	25.40	0.25	0.18	311	NA	1.756	2.048	NA	0.585	0.148
	457	SN02	12.70	0.15	0.18	311	NA	0.878	0.878	NA	0.293	0.127
	457	SN05	5.08	0.15	0.18	311	NA	0.585	0.585	NA	0.293	0.120
	457	BZ10	2.54	0.15	0.20	311	NA	0.585	0.585	NA	0.293	0.120
	457	BN(L)08	3.18	0.08	0.38	578	1,157	0.585	0.585	NA	0.293	0.113
24	610	SN02	12.70	0.13	0.18	890	NA	33.946	34.239	20.777	1.463	0.205
	610	SN04	6.35	0.25	0.18	890	NA	33.946	34.239	20.777	1.171	0.191
	610	SN08	3.18	0.25	0.18	890	NA	33.946	34.239	20.777	1.171	0.184
	610	BZ10	2.54	0.15	0.20	2,682	NA	33.946	34.239	20.777	1.171	0.184
	610	BN(L)05	5.08	0.08	0.38	3,670	6,275	33.946	34.239	20.777	1.171	0.247
	610	BN(L)02	12.70	0.08	0.38	1,521	4,764	33.946	34.239	20.777	0.878	0.282
	610	BNM05	5.00	0.10	0.07	3,861	12,000	33.946	34.239	20.777	1.171	0.340
	610	BNM10	10.00	0.10	0.07	1,930	8,500	33.946	34.239	20.777	1.171	0.340
32	914	BZ10	2.54	0.15	0.20	3,492	NA	68.770	52.382	43.018	2.634	0.353
	914	BN(L)02	12.70	0.10	0.38	2,375	14,964	68.770	52.382	43.018	2.926	0.275
	914	BN(L)05	5.08	0.08	0.38	4,226	7,226	68.770	52.382	43.018	2.634	0.261
	914	BNM05	5.00	0.10	0.07	6,036	13,700	68.770	52.382	43.018	2.926	0.633
	914	BNM10	10.00	0.10	0.07	3,016	21,000	68.770	52.382	43.018	2.926	0.633
	914	BNM20	20.00	0.05	0.13	1,508	11,388	68.770	52.382	43.018	3.219	0.633
50	1219	BZ10	2.54	0.15	0.20	7,936	NA	191.386	323.073	134.029	10.242	0.466
	1219	BN(L)01	25.40	0.10	0.38	3,372	10,231	191.386	323.073	134.029	10.242	0.466
	1219	BN(L)02	12.70	0.10	0.38	6,748	23,820	191.386	323.073	134.029	8.487	0.410
	1219	BN(L)04	6.35	0.10	0.38	13,496	22,949	191.386	323.073	134.029	8.194	0.480
	1219	BNM05	5.00	0.05	0.10	10,440	17,947	191.386	323.073	134.029	7.609	0.847
	1219	BNM10	10.00	0.05	0.10	8,567	14,999	191.386	323.073	134.029	7.609	0.847
	1219	BNM25	25.00	0.10	0.13	3,430	11,285	191.386	323.073	134.029	7.609	0.847
64	1524	BZ10	2.54	0.15	0.20	7,922	NA	674.825	720.184	677.752	40.677	0.614
	1524	BN(L)53	47.93	0.10	0.38	2,393	26,516	674.825	720.184	677.752	52.675	1.412
	1524	BN(L)02	12.70	0.10	0.38	8,981	50,719	674.825	720.184	677.752	41.555	0.600
	1524	BN(L)04	6.35	0.10	0.38	17,917	30,010	674.825	720.184	677.752	40.969	0.607
	1524	BNM05	5.00	0.05	0.10	9,043	29,865	674.825	720.184	677.752	49.749	1.062
	1524	BNM10	10.00	0.05	0.10	9,043	33,253	674.825	720.184	677.752	49.749	1.062
	1524	BNM20	20.00	0.05	0.13	5,703	24,592	674.825	720.184	677.752	49.749	1.062

SCREW CODE	DESCRIPTION
BN	Ball Nut
BNH	Ball Nut H-series
BNL	Low-Backlash Ball Nut
BNM	Ball Nut Metric
BZ	Bronze Nut
RN	Roller Nut
SN	Solid Nut



Contact Tolomatic for higher accuracy and lower backlash options.
† (L) for low backlash ball screws: backlash = 0.0020" (0.05 mm)

* For SN & BZ screws, maximum continuous dynamic thrust subject to Thrust x Velocity limitation.

** For RN, BN & BNL screws, dynamic load rating reflects 90% reliability for 1 million revolutions.

RSA-ST

RSA ST Electric Rod-Style Actuator

SIZE: 12,16: CRITICAL SPEED CAPACITIES

SPECIFICATIONS

sizeit.tolomatic.com
for fast, accurate
actuator selection

RSA-ST

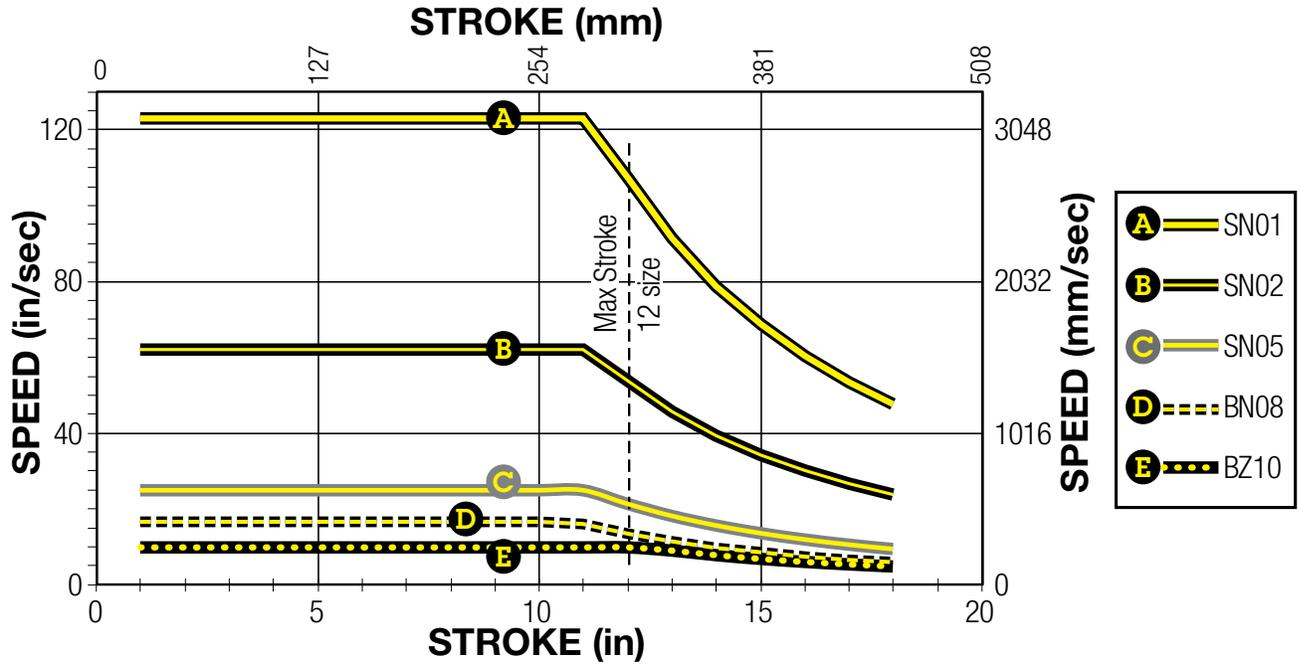

SIZE: 24: CRITICAL SPEED CAPACITIES

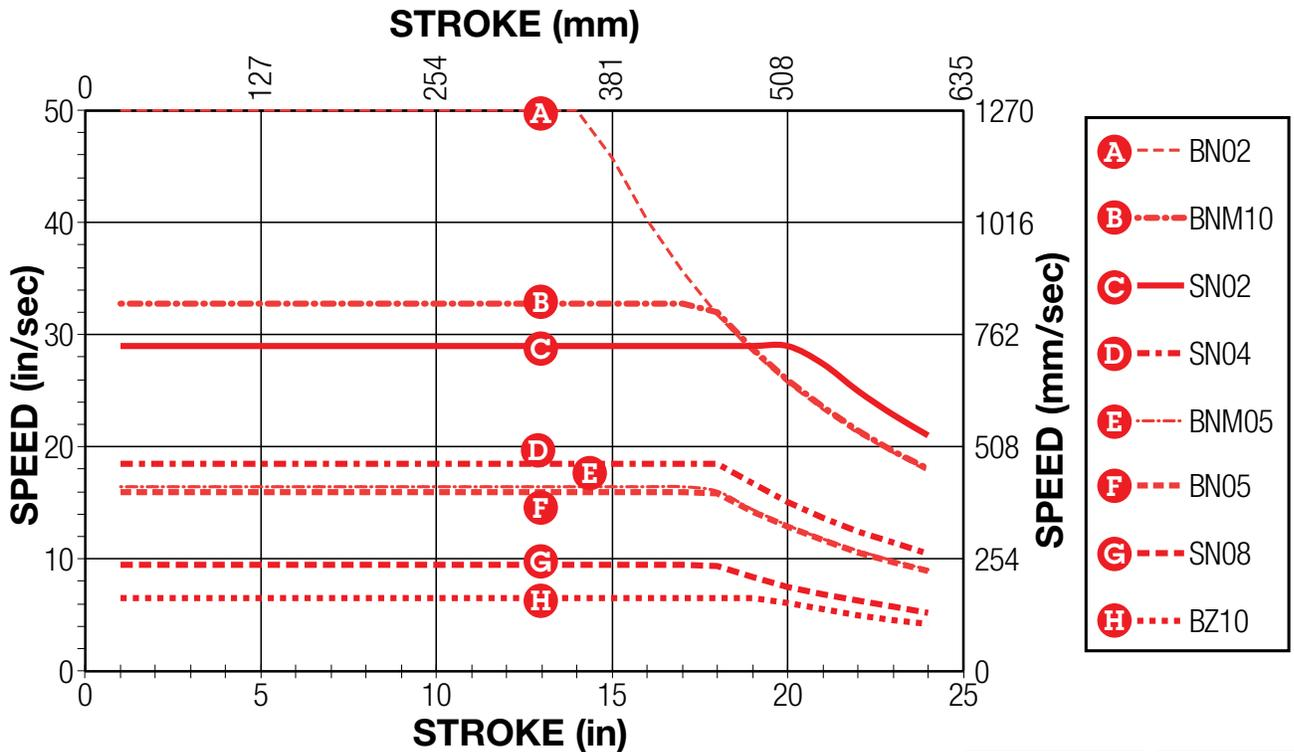

SCREW CODE	DESCRIPTION	SCREW CODE	DESCRIPTION
BN	Ball Nut	BZ	Bronze Nut
BNH	Ball Nut H-series	RN	Roller Nut
BNL	Low-Backlash Ball Nut	SN	Solid Nut
BNM	Ball Nut Metric		

RSA ST Electric Rod-Style Actuator

sizeit.tolomatic.com
for fast, accurate
actuator selection

SIZE: **32: CRITICAL SPEED CAPACITIES**

SPECIFICATIONS

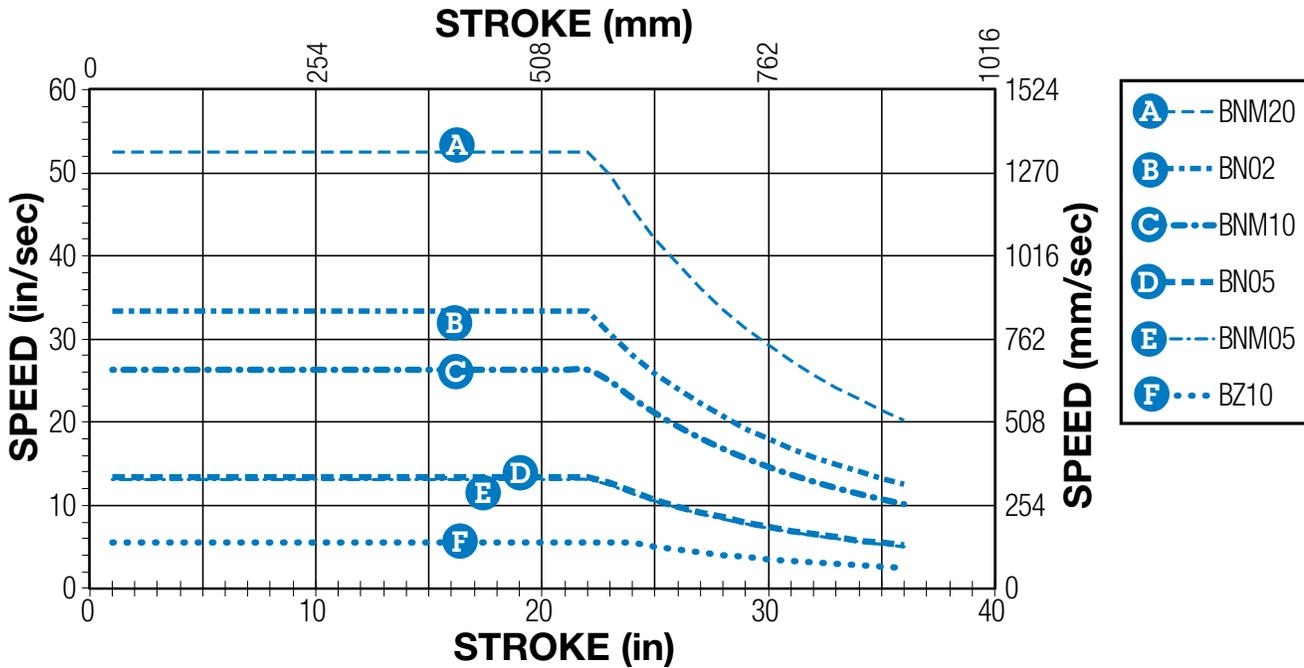

SIZE: **50: CRITICAL SPEED CAPACITIES**

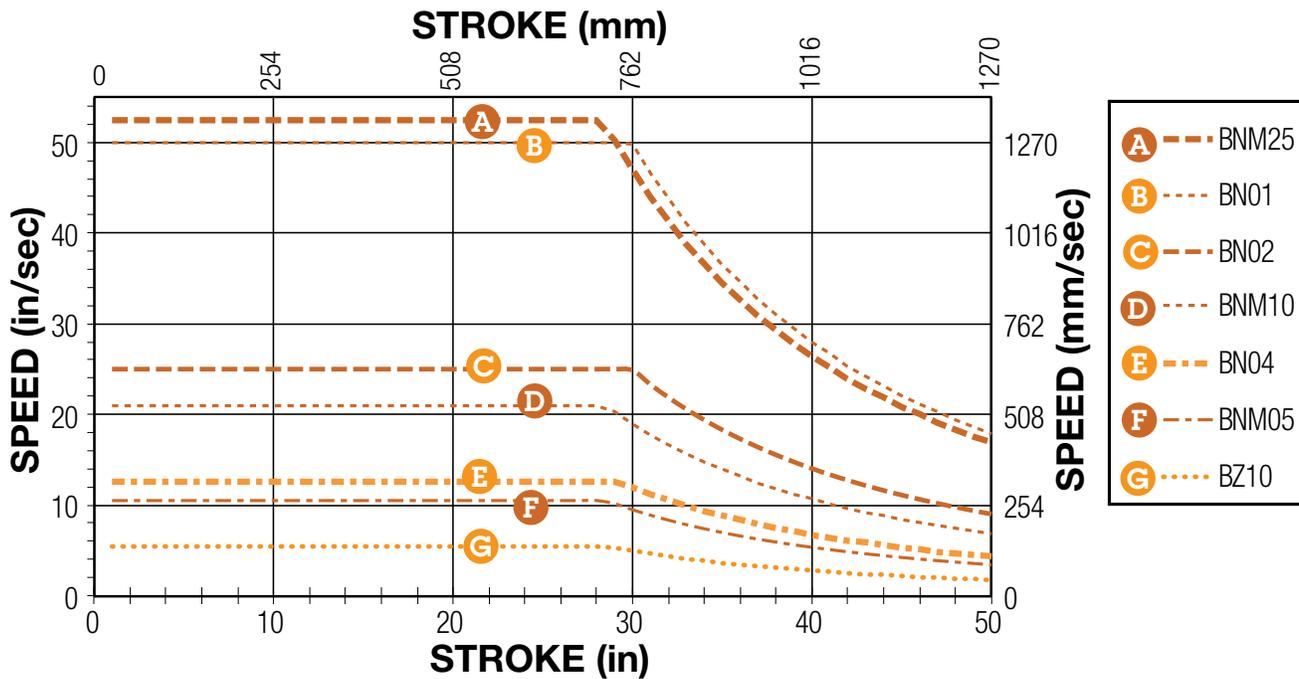

SCREW CODE	DESCRIPTION	SCREW CODE	DESCRIPTION
BN	Ball Nut	BZ	Bronze Nut
BNH	Ball Nut H-series	RN	Roller Nut
BNL	Low-Backlash Ball Nut	SN	Solid Nut
BNM	Ball Nut Metric		

RSA-ST

RSA ST Electric Rod-Style Actuator

sizeit.tolomatic.com
for fast, accurate
actuator selection

SIZE: 64: CRITICAL SPEED CAPACITIES

SPECIFICATIONS

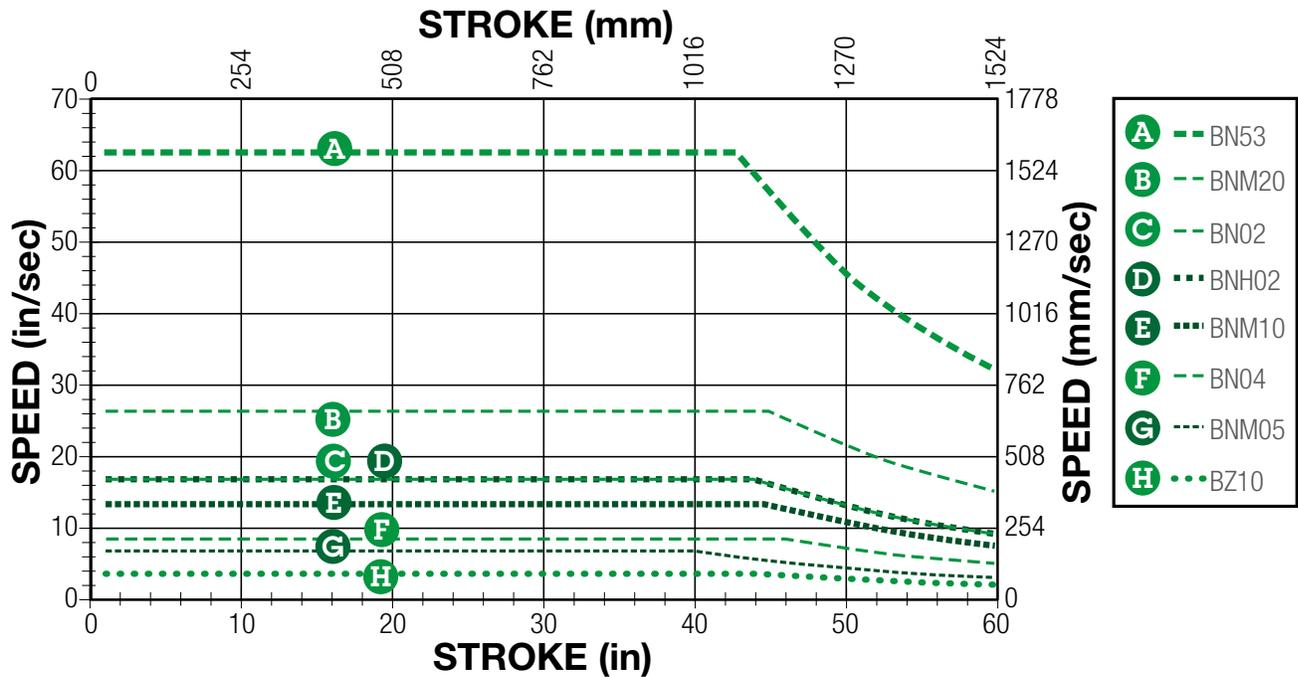

SIZE: 12,16: PV LIMITS (Solid Nuts)

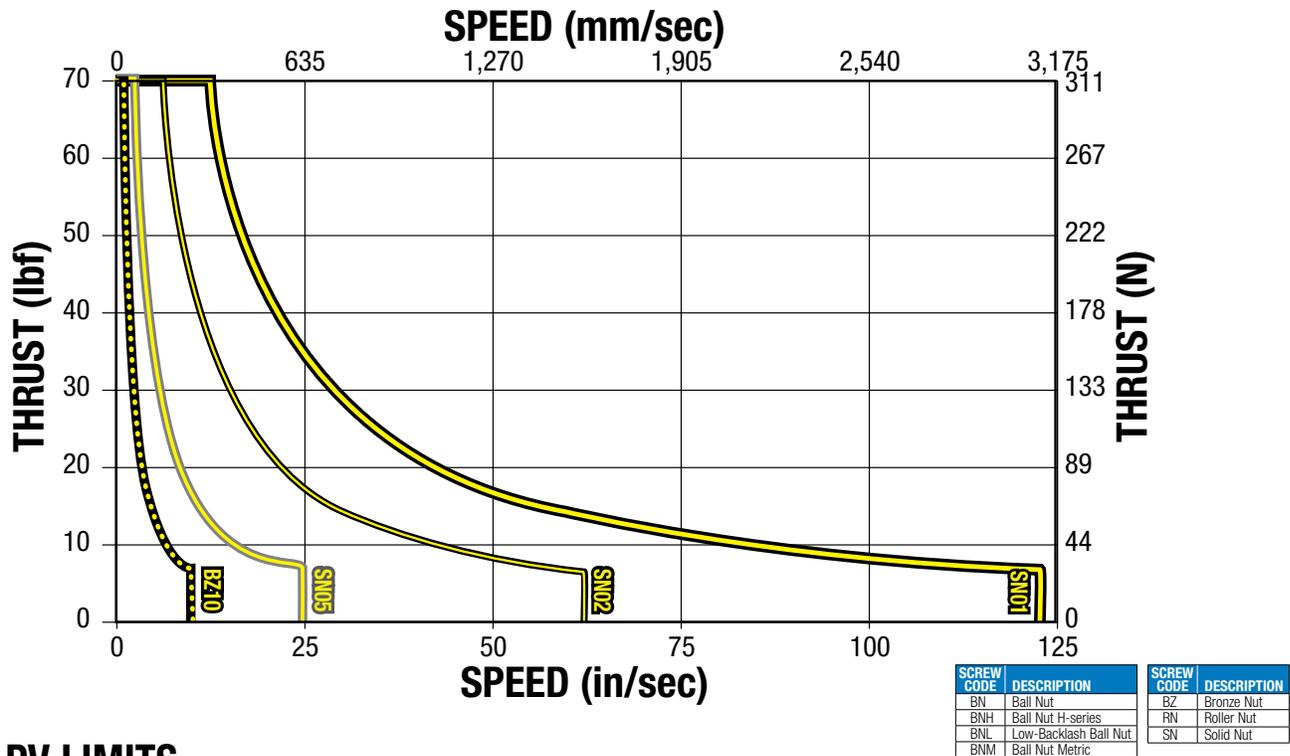

PV LIMITS

PV LIMITS: Any material which carries a sliding load is limited by heat buildup. The factors that affect heat generation rate in an application are the pressure on the nut in pounds per square inch and the surface velocity in feet per minute. The product of these factors provides a measure of the severity of an application.

$$\frac{P}{\text{(Max. Thrust Rating)}} \times \frac{V}{\text{(Max. Speed Rating)}} \leq 0.1$$

RSA ST Electric Rod-Style Actuator

sizeit.tolomatic.com
for fast, accurate
actuator selection

SIZE: 24 (SN): PV LIMITS (Solid Nuts)

SPECIFICATIONS

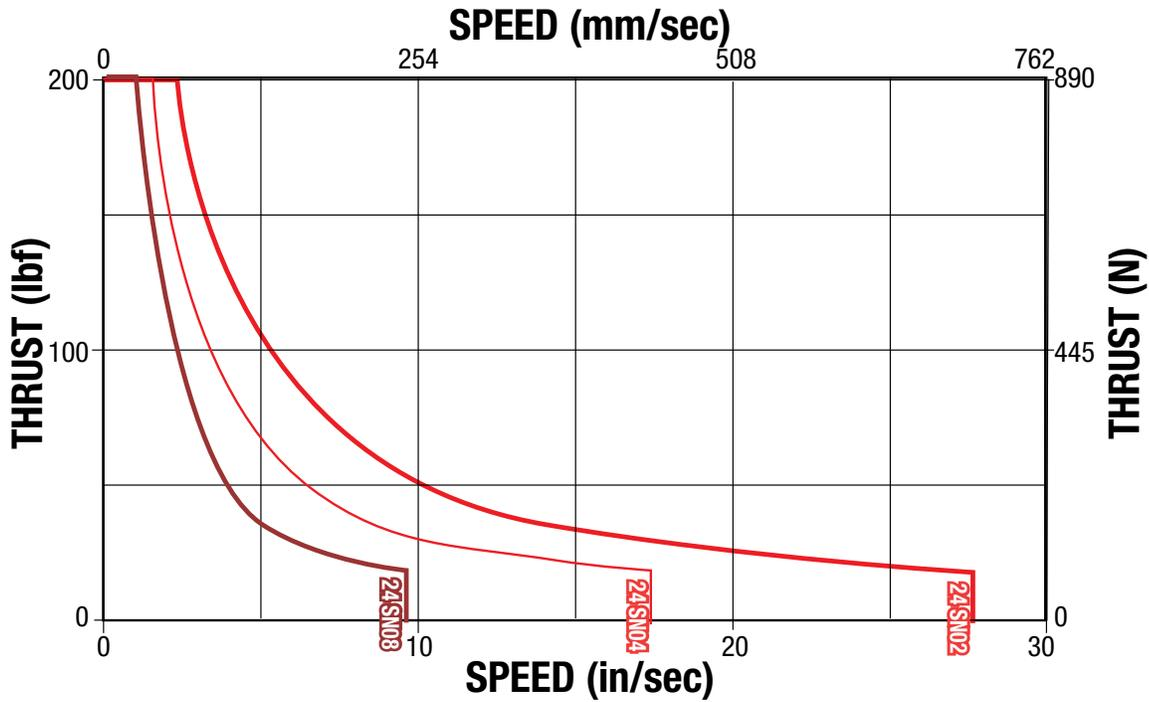

SIZE: 24,32,50,64 (BZ): PV LIMITS (Bronze Nuts)

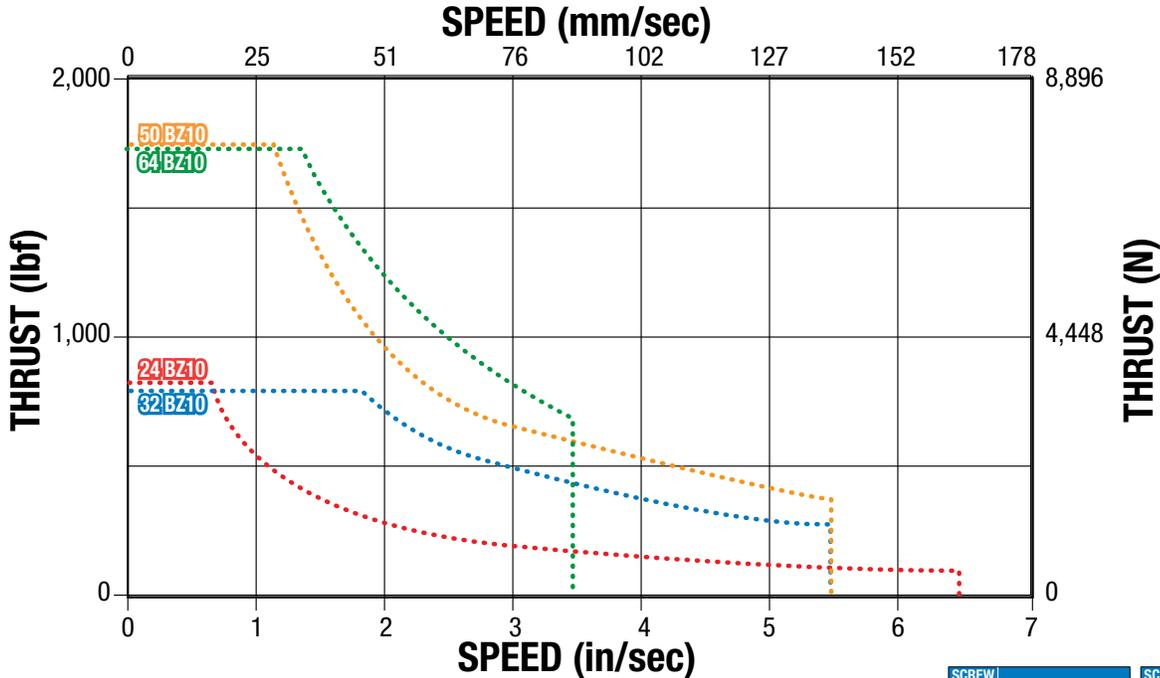

SCREW CODE	DESCRIPTION	SCREW CODE	DESCRIPTION
BN	Ball Nut	BZ	Bronze Nut
BNH	Ball Nut H-series	RN	Roller Nut
BNL	Low-Backlash Ball Nut	SN	Solid Nut
BNM	Ball Nut Metric		

PV LIMITS

PV LIMITS: Any material which carries a sliding load is limited by heat buildup. The factors that affect heat generation rate in an application are the pressure on the nut in pounds per square inch and the surface velocity in feet per minute. The product of these factors provides a measure of the severity of an application.

$$P \times V \leq 0.1$$

$$\left(\frac{\text{Thrust}}{(\text{Max. Thrust Rating})} \right) \times \left(\frac{\text{Speed}}{(\text{Max. Speed Rating})} \right) \leq 0.1$$

RSA-ST

RSA ST Electric Rod-Style Actuator

sizeit.tolomatic.com
for fast, accurate
actuator selection

BALL SCREW LIFE GRAPHS

SPECIFICATIONS

SIZE: 12, 16, 24, 32

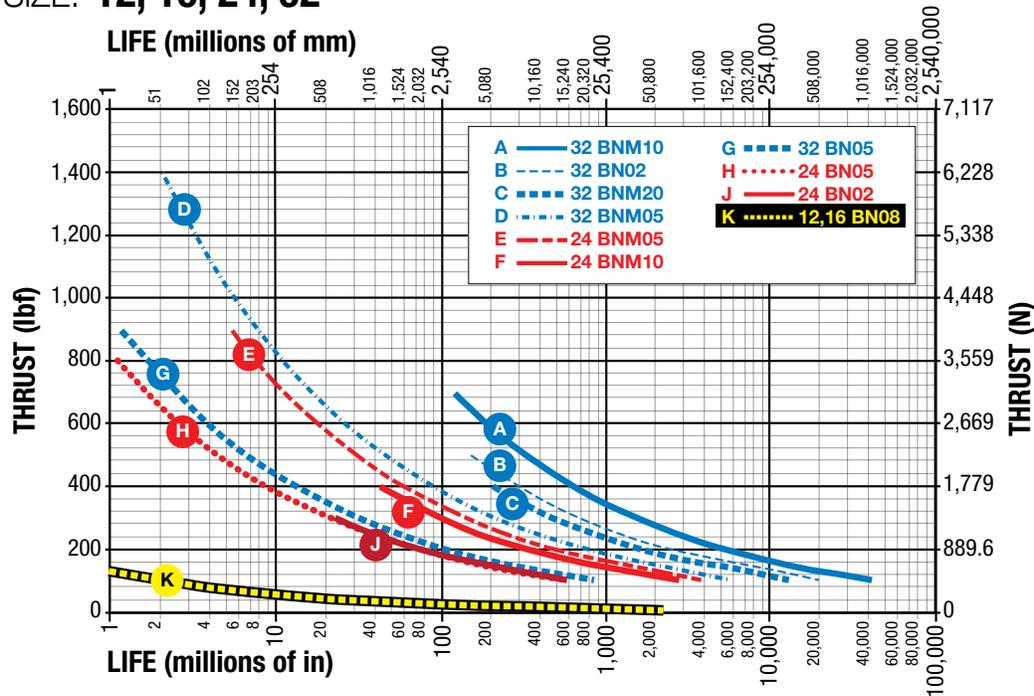

SCREW CODE	DESCRIPTION
BN	Ball Nut
BNH	Ball Nut H-series
BNL	Low-Backlash Ball Nut
BNM	Ball Nut Metric
BZ	Bronze Nut
RN	Roller Nut
SN	Solid Nut

SIZE: 50, 64

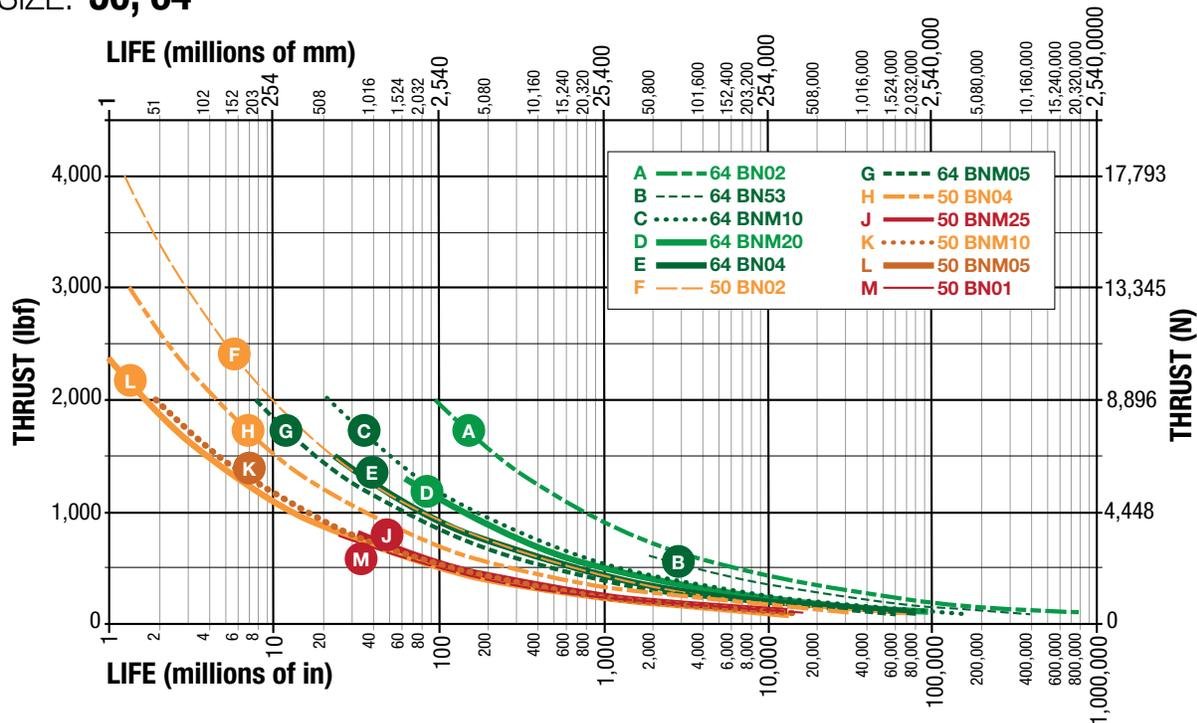

NOTE: The L_{10} expected life of a ball screw linear actuator is expressed as the linear travel distance that 90% of properly maintained ball screw manufactured are expected to meet or exceed. This is not a guarantee and this graph should be used for estimation purposes only.

The underlying formula that defines this value is:

$$L_{10} = \left(\frac{C}{P_e} \right)^3 \cdot \ell =$$

L_{10} Travel life in millions of units (in or mm), where:

C = Dynamic load rating (lbf) or (N)

P_e = Equivalent load (lbf) or (N)

If load is constant across all movements then:

actual load = equivalent load

ℓ = Screw lead (in/rev) (mm/rev)

Use the "Equivalent Load" calculation below, when the load is not constant throughout the entire stroke. In cases where there is only minor variation in loading, use greatest load for life calculations.

Where:
$$P_e = \sqrt[3]{\frac{L_1(P_1)^3 + L_2(P_2)^3 + L_3(P_3)^3 + L_n(P_n)^3}{L}}$$

P_e = Equivalent load (lbf) or (N)

P_n = Each increment at different load (lbf) or (N)

L = Total distanced traveled per cycle (extend + retract stroke)
[$L = L_1 + L_2 + L_3 + L_n$]

L_n = Each increment of stroke at different load (in) or (mm)

RSA ST Electric Rod-Style Actuator

sizeit.tolomatic.com
for fast, accurate
actuator selection

SCREW BUCKLING LOAD

SPECIFICATIONS

SIZE: 12, 16, 24, 32

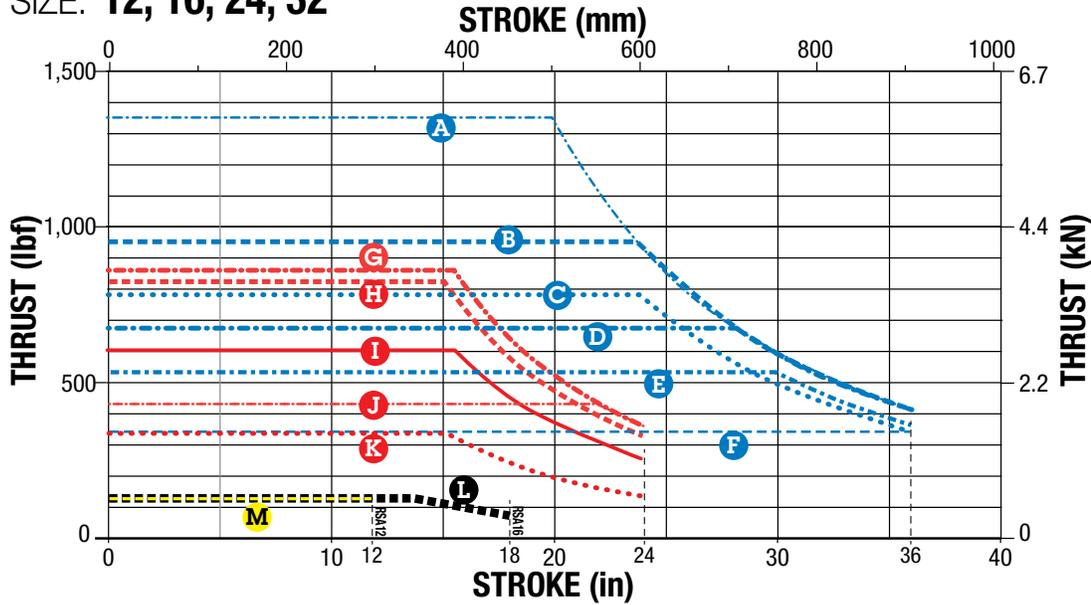

SIZE: 50

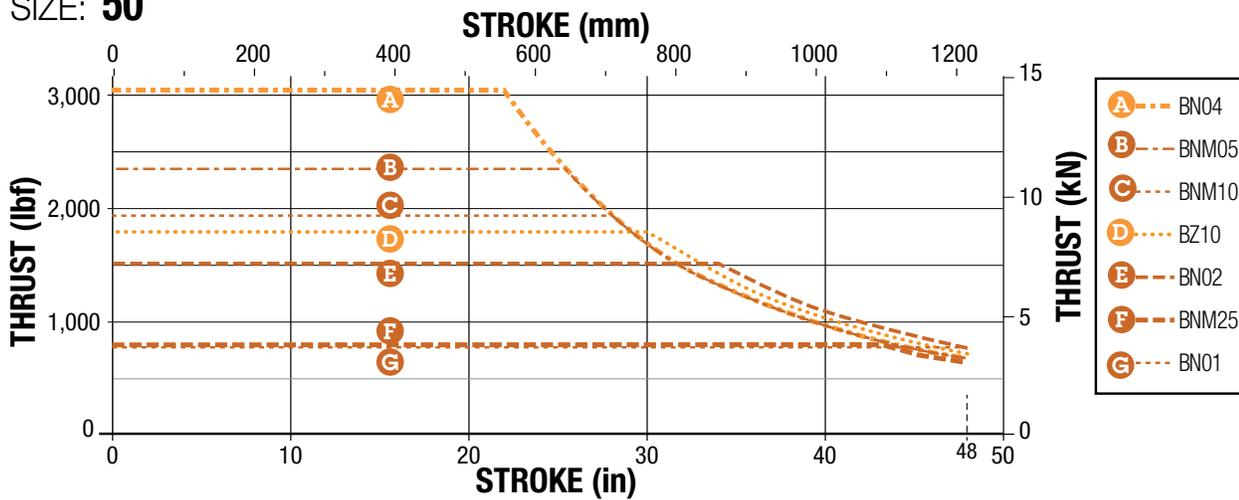

SIZE: 64

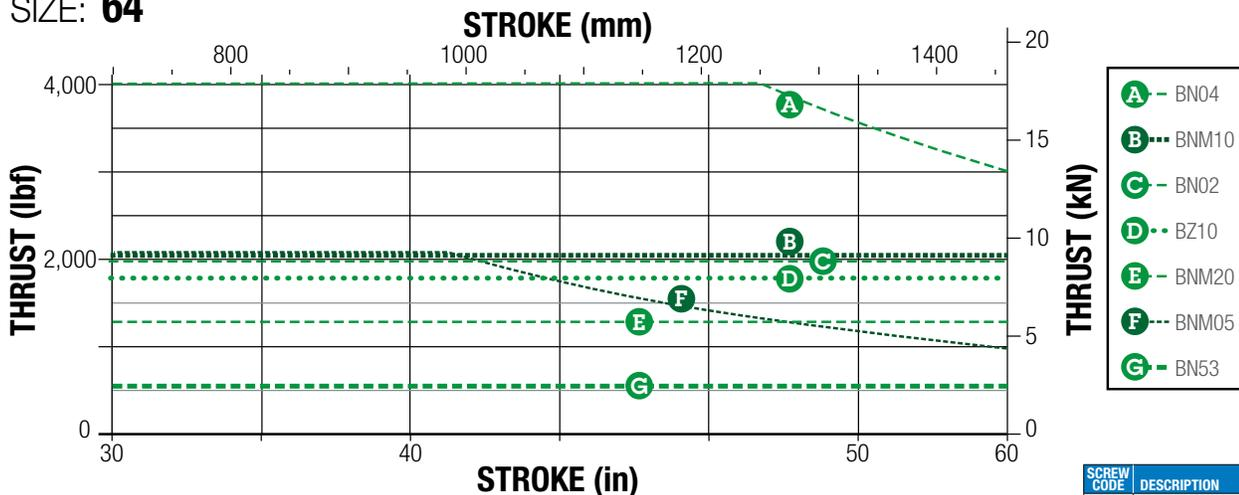

NOTE: Buckling load limits shown assume perfect alignment. It is recommended to use additional safety margin, particularly in high thrust applications

SCREW CODE	DESCRIPTION
BN	Ball Nut
BNH	Ball Nut H-series
BNL	Low-Backlash Ball Nut
BNM	Ball Nut Metric
BZ	Bronze Nut
RN	Roller Nut
SN	Solid Nut

RSA-ST

RSA ST Electric Rod-Style Actuator

sizeit.tolomatic.com
for fast, accurate
actuator selection

SIZE: ALL

SPECIFICATIONS

		RSA SIZE	12	16	24	32	50	64	
WEIGHT	BASE MODEL	IN-LINE	lb	1.73	3.73	3.98	6.11	14.21	23.01
		REVERSE PARALLEL	lb	2.40	4.00	6.25	10.40	19.66	29.69
		PER in OF STROKE	lb/in	0.128	0.300	0.330	0.460	0.860	1.380
MOVING PARTS WEIGHT		BASE WT. BZ & SN	lb	0.11	0.19	0.75	0.97	2.62	5.01
		BASE WT. BN	lb	0.19	0.27	1.01	1.44	3.55	7.59
		PER in OF STROKE	lb/in	0.04	0.06	0.14	0.15	0.33	0.45
MAX. STROKE		in	12.0	18.0	24.0	36.0	48.0	60.0	
TEMP. RANGE*		°F	Standard: 40 to 130 Extended:-40 to 140						



Contact Tolomatic if operation in the extended range is required.

		RSA SIZE	12	16	24	32	50	64	
WEIGHT	BASE MODEL	IN-LINE	kg	0.78	1.68	1.79	2.75	6.39	10.35
		REVERSE PARALLEL	kg	1.08	1.80	2.81	4.68	8.85	13.36
		PER mm OF STROKE	g/mm	2.3	5.3	5.8	8.1	15.2	24.4
MOVING PARTS WEIGHT		BASE WT. BZ & SN	kg	0.05	0.09	0.34	0.44	1.19	2.27
		BASE WT. BN	kg	0.09	0.12	0.46	0.65	1.61	3.44
		PER mm OF STROKE	g/mm	0.71	1.07	2.50	2.68	5.89	8.04
MAX. STROKE		mm	304.8	457.2	609.6	914.4	1219.2	1524	
TEMP. RANGE*		°C	Standard: 4 to 54 Extended:-40 to 60						



Contact Tolomatic if operation in the extended range is required.

Gasket Kit providing ingress protection against dust and splashing water available upon request

⚠ * Heat generated by the motor and drive should be taken into consideration as well as linear velocity and work cycle time. For applications that require operation outside of the recommended temperature range, contact Tolomatic.

LARGE FRAME MOTORS AND SMALLER SIZE ACTUATORS: Cantilevered motors need to be supported, if subjected to continuous rapid reversing duty and/or under dynamic conditions.

SIDE LOADING CONSIDERATIONS: Rod screw actuators are designed to push guided and supported loads and are not meant for applications that require substantial side loading. Please contact Tolomatic for details regarding side loading capabilities.

REVERSE PARALLEL MOUNTING ORDER CODES

Note that these configurations all are shown with the tapped mounting holes at the bottom of the actuator

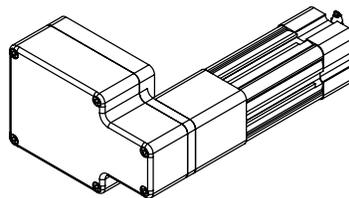

RPL

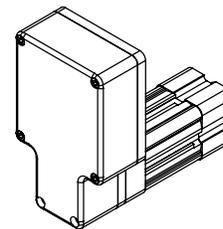

RP

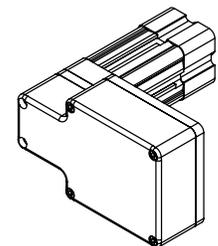

RPR

RSA ST Electric Rod-Style Actuator

SIZE: ALL

DIMENSIONS

tolomatic.com/CAD Download 3D CAD Always use CAD solid model to determine critical dimensions



ST ACTUATOR DIMENSIONS

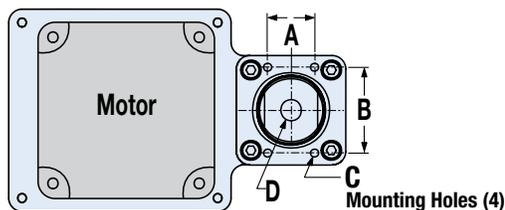

LMI Motor Mount

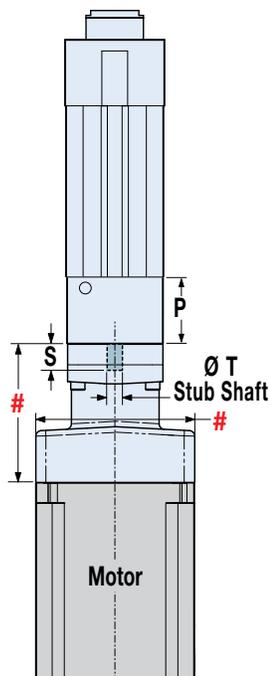

R/P Motor Mount

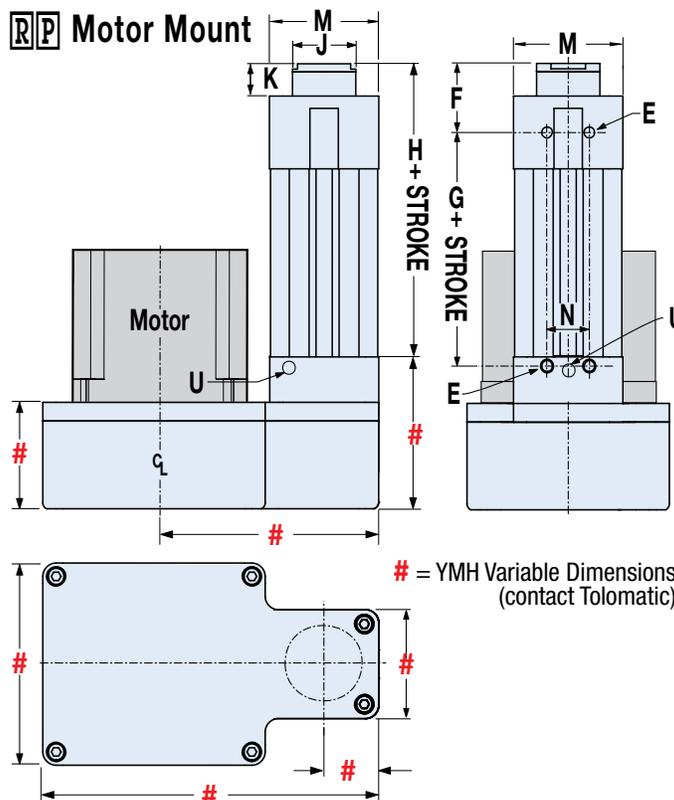

∞NOTE: YM code may change this dimension. Always use configured CAD model to determine critical dimensions

ST ACTUATOR DIMENSIONS

Size							ACME NUT			BALL NUT									
	A	B	C† [4x]	D	E [4x]	F	G	H	G	H	J Ø	K	M	N	P	S	T	U	
12	0.906	0.391	5-40 ∇0.50	1/4-28 ∇0.75	8-32 ∇0.25	0.81	2.17	2.76	2.17	2.76	0.56	0.31	1.13	0.50	0.72	0.61	0.188	-	
16	0.500	1.063	8-32 ∇0.50	5/16-24 ∇0.75	8-32 ∇0.25	1.06	2.13	2.99	2.13	2.99	0.69	0.43	1.38	0.50	0.72	0.61	0.188	-	
24	0.875	1.603	10-24 ∇0.79	7/16-20 ∇1.00	1/4-20 ∇0.31	1.11	2.90	3.84	3.36	4.30	1.18	0.43	2.04	0.79	1.42	0.55	0.315	-	
32	1.181	1.969	1/4-20 ∇0.71	7/16-20 ∇1.13	5/16-18 ∇0.47	1.43	3.87	5.05	5.05	6.23	1.25	0.50	2.58	0.95	1.79	0.69	0.394	1/16-27 NPT	
50	1.969	3.000	5/16-18 ∇1.00	3/4-16 ∇1.50	3/8-16 ∇0.68	1.95	4.78	6.44	5.78	7.44	1.75	0.70	3.71	1.18	2.13	1.36	0.500	1/8-27 NPT	
64	1.969	3.500	7/16-14 ∇1.50	3/4-16 ∇1.50	7/16-14 ∇0.88	2.37	6.94	8.90	8.94	10.90	2.25	0.68	4.58	1.97	3.48	1.36	0.750	1/8-27 NPT	

Dimensions in inches

Size							ACME NUT			BALL NUT									
	A	B	C† [4x]	D	E [4x]	F	G	H	G	H	J Ø	K	M	N	P	S	T	U	
12	23.01	9.93	M3x0.5 ∇12.0	M6x1.0 ∇15	M4x0.7 ∇6.4	20.7	55.1	70.1	55.1	70.1	14.2	7.8	28.6	12.7	18.3	15.5	4.78	-	
16	12.70	27.00	M4x0.7 ∇8.0	M8x1.25 ∇16	M4x0.7 ∇6.4	26.9	54.2	75.9	54.2	75.9	17.5	10.9	35.0	12.7	18.3	15.5	4.78	-	
24	22.23	40.72	M5x0.8 ∇20.0	M10x1.25 ∇25.4	M6x1.0 ∇8.6	28.2	73.7	97.5	85.4	109.2	30.0	10.9	51.8	20.0	36.0	14.0	8.00	-	
32	30.00	50.00	M6x1.0 ∇18.0	M16x1.5 ∇26.6	M8x1.25 ∇12.0	36.3	98.4	128.3	128.3	158.2	31.8	12.7	65.5	24.1	45.4	17.5	10.00	1/16-27 NPT	
50	50.00	76.20	M8x1.25 ∇25.4	M20x1.5 ∇40	M10x1.5 ∇17.3	49.5	121.5	163.6	146.9	189.0	44.5	17.8	94.1	30.0	54.0	34.5	12.70	1/8-27 NPT	
64	50.00	88.90	M12x1.75 ∇38.1	M27x2.0 ∇38.1	M12x1.75 ∇22.2	60.2	176.2	226.1	227.0	276.9	57.2	17.3	116.3	50.0	88.3	34.5	19.05	1/8-27 NPT	

Dimensions in millimeters

RSA ST Rod End Options

SIZE: ALL

DIMENSIONS

tolomatic.com/CAD Download 3D CAD Always use CAD solid model to determine critical dimensions



SRE SPHERICAL ROD END

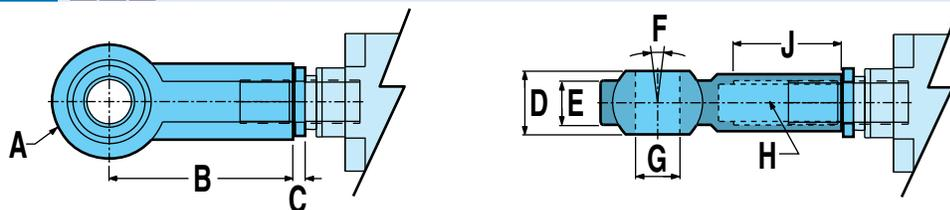

Allows for slight misalignment between the load and the actuator (radial and angular). Uses an industry-standard bearing.

Size		A Ø	B	C	D	E	F	G Ø	H	J
12	in	0.750	1.312	0.10	0.375	0.281	10°	0.250	1/4-28	0.75
	mm	18.00	30.00	2.5	9.00	6.80		6.00	M6x1	12.0
16	in	0.875	1.375	0.10	0.437	0.344		0.312	5/16-24	0.75
	mm	24.00	36.00	2.5	12.00	9.00		8.00	M8x1.25	16.0
24	in	1.125	1.812	0.15	0.560	0.437		0.438	7/16-20	1.06
	mm	28.00	43.00	3.8	14.00	10.50		10.00	M10x1.25	20.0
32	in	1.125	1.812	0.15	0.560	0.437		0.437	7/16-20	1.06
	mm	42.00	64.00	4.8	21.00	15.00		16.00	M16x1.5	28.0
50	in	1.750	2.875	0.19	0.875	0.687		0.750	3/4-16	1.75
	mm	50.00	77.00	4.8	25.00	18.00		20.00	M20x1.5	33.0
64	in	1.750	2.875	0.19	0.875	0.687		0.750	3/4-16	1.75
	mm	70.00	110.00	6.4	37.00	25.00		30.00	M27x2.0	51.0

CLV CLEVIS ROD END

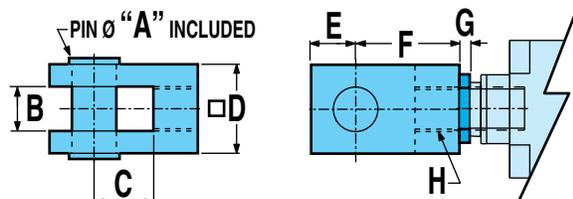

Used with the externally threaded rod end when the actuator has to compensate for misalignment or pivot about an axis.

Size		A Ø	B	C	D	E	F	G	H
12	in	0.250	0.250	0.50	0.50	0.25	0.812	0.10	1/4-28
	mm	6.10 / 6.07	6.01 / 6.14	12.0	12.0	9.5	24.00	2.5	M6x1.0
16	in	0.375	0.375	0.50	0.75	0.38	0.875	0.10	5/16-24
	mm	8.10 / 8.07	6.01 / 6.14	16.0	16.0	13.0	32.00	2.5	M8x1.25
24	in	0.50	0.51	0.75	1.00	0.50	1.375	0.15	7/16-20
	mm	10.0	10.0	20.0	20.0	16.0	40.00	3.8	M10x1.25
32	in	0.50	0.51	0.75	1.00	0.50	1.375	0.15	7/16-20
	mm	16.0	16.0	32.0	32.0	19.0	64.00	4.8	M16x1.5
50	in	0.75	0.75	1.00	1.50	0.75	1.750	0.19	3/4-16
	mm	20.0	20.0	40.0	40.0	25.0	80.00	4.8	M20x1.5
64	in	0.75	0.75	1.00	1.50	0.75	1.750	0.19	3/4-16
	mm	30.0	30.0	54.0	55.0	45.0	110.00	6.4	M27x2.0

KEY TO SYMBOLS

- ▲ Indicates a note of high importance
- ⊗ Indicates incompatibility with option(s) or size(s)
- 📄 Make note of this item

RSA ST Rod End Options

SIZE: ALL

DIMENSIONS

tolomatic.com/CAD Download 3D CAD Always use CAD solid model to determine critical dimensions



MET EXTERNALLY THREADED ROD END



An alternative to the standard internally threaded end.

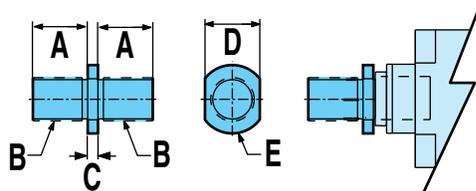

Size		A	B	C	D	E Ø
12	in	0.50	1/4-28	0.10	0.315	0.42
	mm	12.7	M6x1.0	2.5	8.00	10.7
16	in	0.50	5/16-24	0.10	0.375	0.48
	mm	12.7	M8x1.25	2.5	10.00	12.2
24	in	0.87	7/16-20	0.15	0.750	0.97
	mm	22.1	M10x1.25	3.8	19.00	24.6
32	in	0.87	7/16-20	0.15	0.750	0.97
	mm	28.0	M16x1.5	4.8	19.00	24.6
50	in	1.50	3/4-16	0.19	1.250	1.48
	mm	38.1	M-20x1.5	4.8	32.00	37.6
64	in	1.50	3/4-16	0.19	1.250	1.48
	mm	38.1	M27x2	6.4	32.00	38.1

ALC ALIGNMENT COUPLER

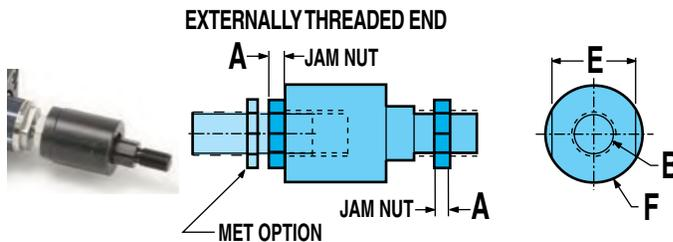
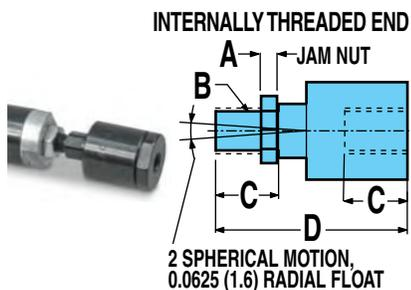

THE ALIGNMENT COUPLER COMES WITH AN INTERNAL THREAD. IF AN EXTERNAL THREAD IS PREFERRED, THE ADDITION OF THE "MET" OPTION IS REQUIRED.

Size		A	B	C	D	E	F
12	in	0.16	1/4-28	0.63	1.88	0.81	0.88
	mm	-	-	-	-	-	-
16	in	0.20	5/16-24	0.63	1.88	0.81	0.88
	mm	-	-	-	-	-	-
24	in	0.25	7/16-20	0.75	2.75	1.13	1.25
	mm	6.4	M10x1.25	24.0	77.0	19.0	30.0
32	in	0.25	7/16-20	0.75	2.75	1.13	1.25
	mm	8.0	M16x1.5	32.0	106.0	30.0	42.0
50	in	0.45	3/4-16	1.13	3.44	1.50	1.75
	mm	10.0	M20x1.5	42.0	122.0	30.0	42.0
64	in	0.45	3/4-16	1.13	3.44	1.50	1.75
	mm	13.5	M27x2.0	54.0	147.0	32.0	55.0

Used in combination with the externally threaded rod end to provide smooth motion and extends actuator life by preventing binding caused by angular or axial misalignment. Not available for use with clevis or trunnion mounts, as they must be rigidly mounted.



If you need external thread, be sure to also order the **MET** external rod end

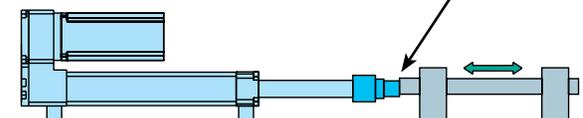
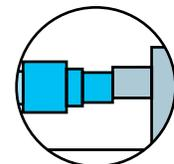

RSA ST Mounting Options

SIZE: ALL

DIMENSIONS

tolomatic.com/CAD Download 3D CAD Always use CAD solid model to determine critical dimensions



FFG FRONT FLANGE MOUNT



Used when a bottom-tapped mount is not an option or where bottom support mechanisms are not feasible.

Flange can be mounted directly to framework or a bulkhead

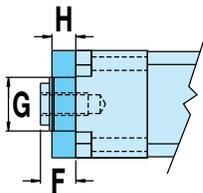
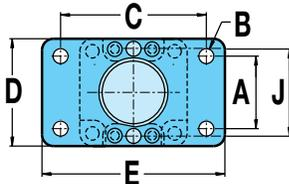

Size		A	B Ø	C	D	E	F	G Ø	H	J
12	in	0.500	0.157	1.500	1.12	2.00	0.31	0.72	0.25	—
	mm	12.70	4.00	38.10	28.5	50.8	7.8	18.3	6.3	—
16	in	0.945	0.18	1.896	1.38	2.39	0.43	0.81	0.37	—
	mm	24.00	4.5	48.16	35.1	60.7	11.0	20.5	9.3	—
24	in	1.430	0.31	2.750	2.00	3.37	0.43	1.34	0.37	—
	mm	32.00	7.2	64.00	47.0	80.0	11.0	34.0	10.0	—
32	in	1.840	0.37	3.375	2.50	4.12	0.50	1.50	0.37	—
	mm	45.00	9.2	90.00	65.0	113.0	12.7	34.0	12.0	—
50	in	2.760	0.43	4.687	3.75	5.50	0.70	1.90	0.62	—
	mm	63.00	12.2	126.00	97.0	153.0	17.7	48.3	16.0	—
64	in	3.320	0.45	5.437	4.50	6.25	0.68	2.40	0.62	—
	mm	84.33	14.2	150.00	111.0	186.0	17.3	61.0	16.0	—

ADDITIONAL FFG MOUNT ORDER CODES

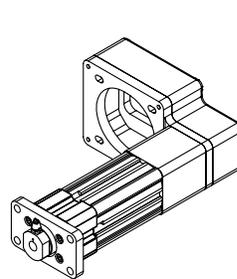

FFG RPR

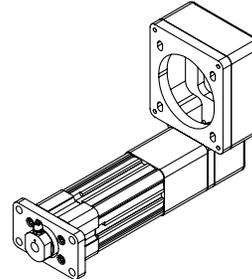

FFG RP

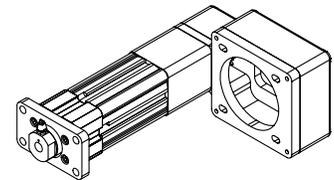

FFG RPL

Note that these configurations all are shown with the tapped mounting holes at the bottom of the actuator (These additional ordering codes are unnecessary if the tapped mounting holes are not used)

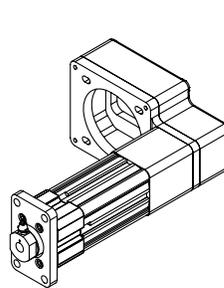

FFGR RPR

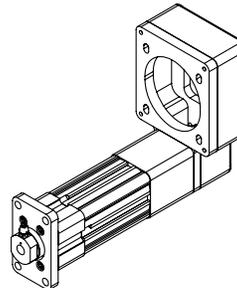

FFGR RP

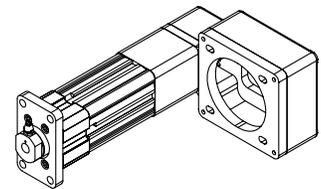

FFGR RPL

RSA ST Mounting Options

SIZE: ALL

DIMENSIONS

tolomatic.com/CAD Download 3D CAD Always use CAD solid model to determine critical dimensions



M P 2 MOUNTING PLATE

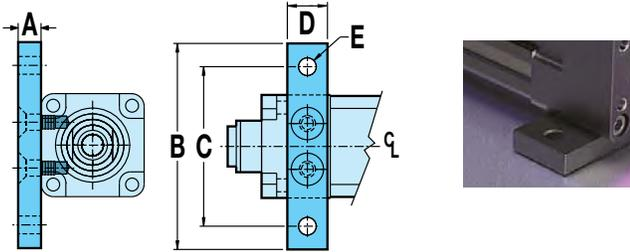

Used for mountings other than flush.

Size		A	B	C	D	E Ø
12 17 FRAME	in	0.50	2.25	1.75	0.40	0.19
	mm	12.7	57.2	44.4	10.2	4.8
12 23 FRAME or YMH option	in	0.63	2.50	2.00	0.40	0.19
	mm	16.0	63.5	50.8	10.2	4.8
16	in	0.63	2.50	2.00	0.40	0.19
	mm	16.0	63.5	50.8	10.2	4.8

Size		A	B	C	D	E Ø
24	in	0.50	3.50	2.75	1.50	0.44
	mm	12.0	78.0	62.0	25.4	6.7
32	in	0.50	4.00	3.25	1.50	0.44
	mm	12.0	104.0	84.0	31.8	8.70
50	in	0.75	5.75	4.75	1.75	0.56
	mm	20.0	144.0	120.0	30.5	11.0
64	in	0.75	6.50	5.50	1.75	0.56
	mm	20.0	180.0	150.0	57.2	12.8

B F G BACK FLANGE MOUNT

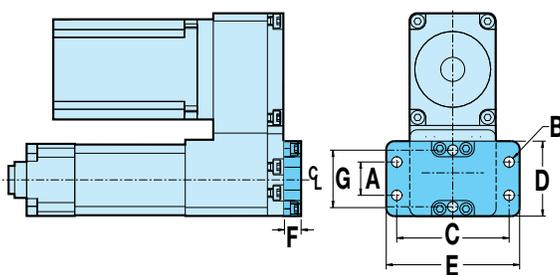

Size		A	B Ø	C	D	E	F	G
12	in	0.500	0.157	1.500	1.12	2.00	0.25	—
	mm	12.70	4.00	38.10	28.5	50.8	6.35	—
16	in	0.945	0.18	1.896	1.38	2.39	0.37	—
	mm	24.00	4.5	48.16	35.1	60.7	9.40	—
24	in	1.430	0.31	2.750	2.00	3.37	0.37	—
	mm	32.00	7.2	64.00	47.0	80.0	9.40	—
32	in	1.840	0.37	3.375	2.50	4.12	0.37	—
	mm	45.00	9.2	90.00	65.0	113.0	9.40	—
50	in	2.760	0.43	4.687	3.75	5.50	0.62	—
	mm	63.00	12.2	126.00	97.0	153.0	15.7	—
64	in	3.320	0.43	5.437	4.50	6.25	0.62	—
	mm	75.00	14.2	150.00	111.0	186.0	15.7	—

Used when a bottom-tapped mount is not an option or where bottom support mechanisms are not feasible. Flange can be mounted directly to framework or a bulkhead

⊗ Not available with LMI (inline) motor mounting

ADDITIONAL BFG MOUNT ORDER CODES

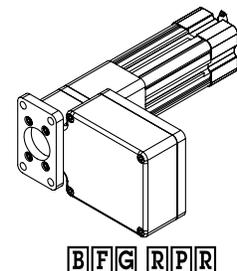
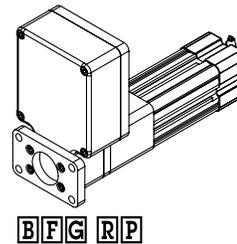
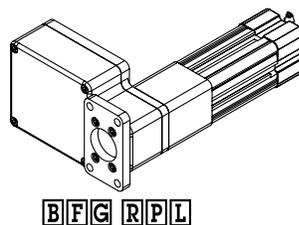

Note that these configurations all are shown with the tapped mounting holes at the bottom of the actuator (These additional ordering codes are unnecessary if the tapped mounting holes are not used)

RSA ST Mounting Options

SIZE: ALL

DIMENSIONS

tolomatic.com/CAD Download 3D CAD Always use CAD solid model to determine critical dimensions



P C S EYE MOUNT & P C D CLEVIS MOUNT



Used when the actuator has to compensate for misalignment or pivot about an axis when free movement is available in the back of the actuator.

⊗ Not available with LMI (inline) motor mounting



Used when the actuator has to compensate for misalignment or pivot about an axis when free movement is available in the back of the actuator.

⊗ Not available with LMI (inline) motor mounting.

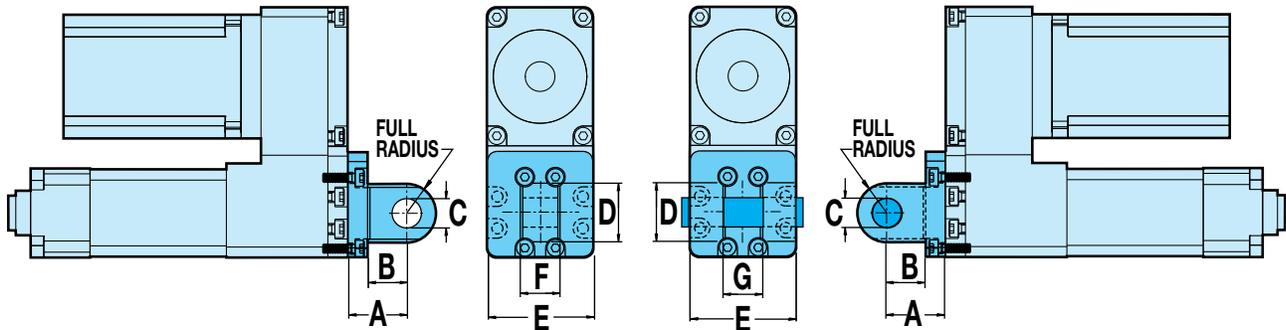

Size		A	B	C Ø	D	E	F	G
12	in	0.750	0.500	0.3761 / 0.3751	0.75	1.34	0.447 / 0.442	0.453 / 0.448
	mm	19.05	12.70	10.018 / 10.000	19.0	34.0	11.35 / 11.22	11.51 / 11.38
16	in	0.750	0.500	0.3761 / 0.3751	0.75	1.34	0.447 / 0.442	0.453 / 0.448
	mm	19.05	12.70	10.018 / 10.000	19.0	34.0	11.35 / 11.22	11.51 / 11.38
24	in	1.062	0.687	0.501 / 0.500	1.00	1.98	0.750 / 0.745	0.755 / 0.751
	mm	22.00	12.00	10.03 / 10.00	20.0	50.2	25.80 / 25.60	26.12 / 26.01
32	in	1.062	0.687	0.501 / 0.500	1.00	2.58	0.750 / 0.745	0.755 / 0.751
	mm	27.00	15.00	12.03 / 12.00	26.0	65.5	31.80 / 31.60	32.12 / 32.01
50	in	1.875	1.375	0.751 / 0.750	1.50	3.60	1.250 / 1.245	1.255 / 1.251
	mm	36.00	20.00	16.03 / 16.00	40.0	91.5	49.80 / 49.60	50.12 / 50.01
64	in	1.875	1.375	0.751 / 0.750	1.50	4.48	1.250 / 1.245	1.255 / 1.251
	mm	44.00	26.00	20.03 / 20.00	40.0	113.7	59.80 / 59.60	60.12 / 60.01

KEY TO SYMBOLS

- ▲ Indicates a note of high importance
- ⊗ Indicates incompatibility with option(s) or size(s)
- 📄 Make note of this item

RSA ST Mounting Options

SIZE: ALL

DIMENSIONS

tolomatic.com/CAD Download 3D CAD Always use CAD solid model to determine critical dimensions



ADDITIONAL PCS and PCD MOUNT ORDER CODES

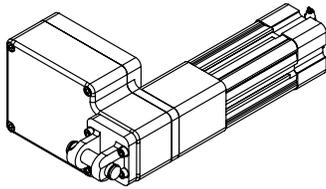

PCD RPL

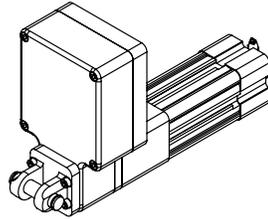

PCD RP

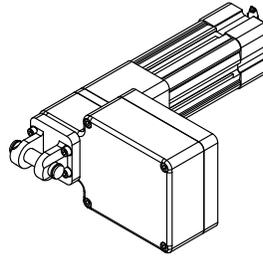

PCD RPR

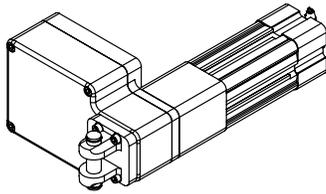

PCDR RPL

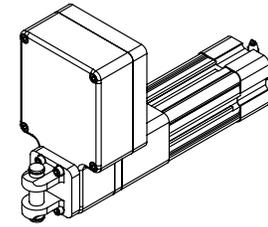

PCDR RP

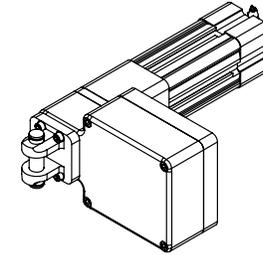

PCDR RPR

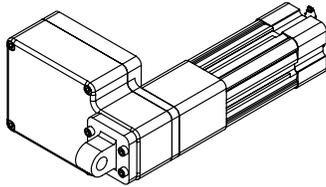

PCS RPL

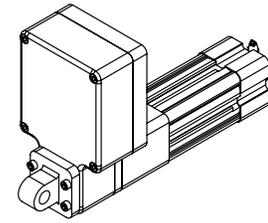

PCS RP

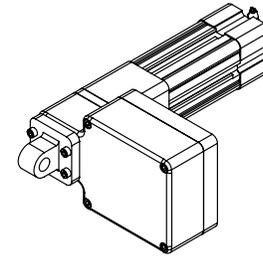

PCS RPR

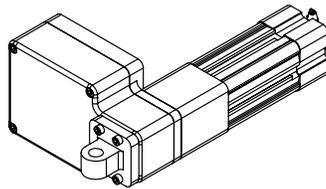

PCSR RPL

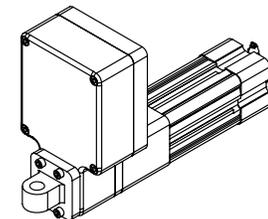

PCSR RP

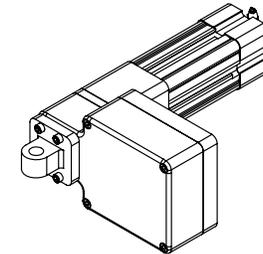

PCSR RPR

Note that these configurations all are shown with the tapped mounting holes at the bottom of the actuator (These additional ordering codes are unnecessary if the tapped mounting holes are not used)

RSA ST Mounting Options

SIZE: ALL

DIMENSIONS

tolomatic.com/CAD Download 3D CAD Always use CAD solid model to determine critical dimensions



TRUNNION MOUNT



Used where space is limited in the rear of the actuator and when pivoting about an axis is required.

⊗ Not available with 12 or 16 size LMI (inline) motor mounting

RSA US standard
(Sizes: 24, 32, 50, 64)

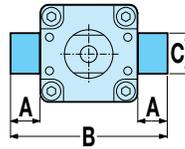

RSM Metric
(+RSA12, RSA16)

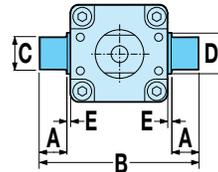

Both RSA US standard
RSM Metric



RSA: US standard	Size		A	B	C Ø	D Ø	E	F (LMI)			F (RP)		
								ACME NUT	BALL NUT	ROLLER NUT	ACME NUT	BALL NUT	ROLLER NUT
	12	in	0.38	2.25	0.4374/0.4368	0.562	0.078	NA	NA	NA	3.09	3.09	NA
	16	in	0.38	2.25	0.4374/0.4368	0.562	0.078	NA	NA	NA	3.30	3.30	NA
	24	in	1.04	4.12	0.9999/0.9993	NA	NA	4.46	4.94	6.33	4.30	4.73	6.33
	32	in	1.00	4.58	0.9999/0.9993	NA	NA	6.06	7.24	7.42	5.65	6.83	7.42
	50	in	1.06	5.83	0.9999/0.9993	NA	NA	7.44	8.44	NA	7.14	8.14	NA
	64	in	1.06	6.70	0.9999/0.9993	NA	NA	9.90	11.90	NA	9.80	11.80	NA

RSM: Metric	Size		A	B	C Ø	D Ø	E	F (LMI)			F (RP)		
								ACME NUT	BALL NUT	ROLLER NUT	ACME NUT	BALL NUT	ROLLER NUT
	12	mm	9.5	57.2	11.981/11.999	14.3	2.0	NA	NA	NA	78.5	78.5	NA
	16	mm	9.5	57.2	11.981/11.999	14.3	2.0	NA	NA	NA	83.8	83.8	NA
	24	mm	8.6	75.7	11.96/11.99	18.0	3.3	113.4	125.5	160.8	109.1	120.2	160.8
	32	mm	16.0	107.0	15.95/15.98	25.0	4.74	153.8	183.8	188.5	143.5	173.5	188.5
	50	mm	20.1	150.1	19.95/19.98	30.0	7.9	191.0	214.4	NA	181.3	206.7	NA
	64	mm	24.9	181.9	24.97/24.99	40.0	7.9	251.6	302.4	NA	248.9	299.7	NA

RSA ST Mounting Options

SIZE: ALL

DIMENSIONS

tolomatic.com/CAD Download 3D CAD Always use CAD solid model to determine critical dimensions



✗ FM2 FOOT MOUNTS DISCONTINUED (FOR REFERENCE ONLY)



Used when mounting holes on bottom of actuator are not accessible.

✗ Not available with LMI (inline) motor mounting

✗ Not available with HT option

Size		A	B	C Ø	D	E	F	G
12	in	0.16	0.55	0.15	0.75	1.13	0.77	0.09
	mm	4.1	14.0	3.9	19.1	28.6	19.7	2.3
16	in	0.16	0.55	0.15	0.77	1.34	1.00	0.09
	mm	4.1	14.0	3.9	19.7	34.0	25.4	2.3
24	in	0.37	1.00	0.33	1.19	2.04	1.25	0.12
	mm	7.1	23.9	7.0	29.9	51.8	32.2	3.0
32	in	0.37	1.00	0.41	1.43	2.58	1.75	0.13
	mm	9.5	32.0	9.0	36.3	64.0	45.0	3.2
50	in	0.50	1.25	0.46	1.93	3.70	2.75	0.12
	mm	16.5	41.0	12.0	49.1	96.0	63.0	3.2
64	in	0.50	1.25	0.46	2.32	4.58	3.50	0.12
	mm	19.0	41.0	14.0	59.0	113.0	75.0	3.2

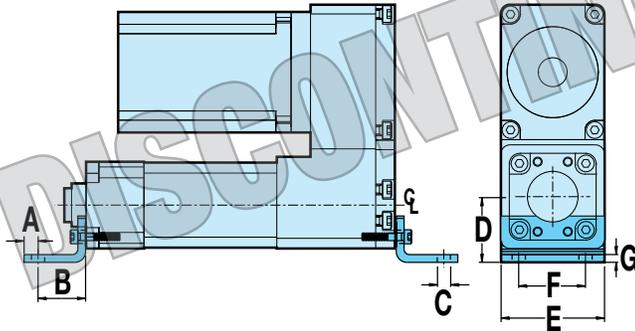

XR OPTIONAL ROD EXTENSION

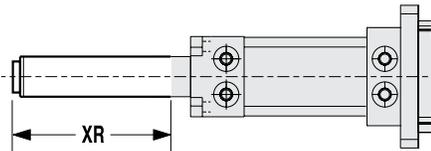

In **vertical applications only**, the thrust rod length can be extended by specifying the rod extension option. This does not increase the working stroke, only the length of the thrust rod.

NOTE: the XR dimension in the configurator string (extension + stroke) should not exceed the maximum stroke of the specified actuator. Consult Tolomatic for extensions greater than the maximum stroke length.

Maximum Stroke Length

Size		All Screws
12	in	12
	mm	305
16	in	18
	mm	457
24	in	24
	mm	610
32	in	36
	mm	914
50	in	48
	mm	1219
64	in	60
	mm	1524

RSA HT Electric Rod-Style Actuator

SIZE: **24, 32, 50, 64** units: **US standard**

SPECIFICATIONS



sizeit.tolomatic.com
for fast, accurate
actuator selection

RSA SIZE	MAX. STROKE in	SCREW CODE	TPI turns/in	LEAD ACCUR- ACY in/ft	BACK- LASH † in	MAX. THRUST* lbf	DYNAMIC LOAD RATING** lbf	BASE ACTUATOR INERTIA			INERTIA PER/in OF STROKE lb-in ²	DYNAMIC TORQUE TO OVERCOME FRICTION lb-in
								Reverse Parallel				
								In Line lb-in ²	1:1 lb-in ²	2:1 lb-in ²		
24	24	RN04	6.35	0.0004	0.0012	1,700	5,577	0.709	0.188	0.115	0.004	5.30
	24	RN05	5.08	0.0004	0.0012	1,700	5,577	0.709	0.188	0.115	0.004	5.30
	24	RN10	2.54	0.0004	0.0012	1,556	5,577	0.709	0.188	0.115	0.004	5.30
32	36	BZ10	10.00	0.0060	0.0080	2,500	NA	2.252	0.338	0.160	0.009	3.13
	36	BN(L)02	2.00	0.0040	0.0150	2,500	3,364	2.252	0.338	0.160	0.010	2.44
	36	BN(L)05	5.00	0.0030	0.0150	950	1,624	2.252	0.338	0.160	0.009	2.31
	36	BNM05	5.08	0.0040	0.0030	1,792	3,080	2.252	0.338	0.160	0.010	5.60
	36	BNM10	2.54	0.0040	0.0030	2,473	4,721	2.252	0.338	0.160	0.010	5.60
	36	BNM20	1.27	0.0020	0.0050	2,364	2,560	2.252	0.338	0.160	0.011	5.60
	36	RN04	6.35	0.0004	0.0012	4,159	12,761	2.692	1.751	0.784	0.011	6.20
	36	RN05	5.08	0.0004	0.0012	3,878	12,761	2.692	1.751	0.784	0.011	6.20
50	36	RN10	2.54	0.0004	0.0012	4,159	12,761	2.692	1.751	0.784	0.011	6.20
	48	BZ10	10.00	0.0060	0.0080	3,500	NA	6.537	2.026	0.843	0.035	4.13
	48	BN(L)01	1.00	0.0040	0.0150	2,300	2,300	6.537	2.026	0.843	0.035	4.13
	48	BN(L)02	2.00	0.0040	0.0150	4,250	5,355	6.537	2.026	0.843	0.029	3.63
	48	BN(L)04	4.00	0.0040	0.0150	3,250	5,159	6.537	2.026	0.843	0.028	4.25
	48	BNM05	5.08	0.0020	0.0040	2,347	4,035	6.537	2.026	0.843	0.026	7.50
	48	BNM10	2.54	0.0020	0.0040	2,471	3,372	6.537	2.026	0.843	0.026	7.50
	48	BNM25	1.02	0.0040	0.0050	2,524	2,537	6.537	2.026	0.843	0.026	7.50
64	36 [§]	RN05	5.08	0.0004	0.0012	7,868	16,245	7.072	9.859	4.379	0.060	8.50
	36 [§]	RN10	2.54	0.0004	0.0012	7,868	16,245	7.072	9.859	4.379	0.060	8.50
	60	BZ10	10.00	0.0060	0.0080	7,000	NA	16.342	13.578	7.670	0.139	5.44
	60	BN(L)53	0.53	0.0040	0.0150	3,500	5,961	16.342	13.578	7.670	0.180	12.50
	60	BN(L)02	2.00	0.0040	0.0150	9,050	11,402	16.342	13.578	7.670	0.142	5.31
	60	BN(L)04	4.00	0.0040	0.0150	4,250	6,746	16.342	13.578	7.670	0.140	5.38
	60	BNM05	5.08	0.0020	0.0040	3,906	6,714	16.342	13.578	7.670	0.170	9.40
	60	BNM10	2.54	0.0020	0.0040	5,479	7,476	16.342	13.578	7.670	0.170	9.40
64	60	BNM20	1.27	0.0020	0.0050	5,105	5,528	16.342	13.578	7.670	0.170	9.40
	60	BNH(L)02	2.00	0.0040	0.0020	12,900	16,253	16.342	13.578	7.670	0.140	9.40
	36 [§]	RN05	5.08	0.0004	0.0012	13,039	23,843	16.342	13.578	7.670	0.125	9.40
	36 [§]	RN10	2.54	0.0004	0.0012	11,997	23,954	16.342	13.578	7.670	0.125	9.40

SCREW CODE	DESCRIPTION
BN	Ball Nut
BNH	Ball Nut H-series
BNL	Low-Backlash Ball Nut
BNM	Ball Nut Metric
BZ	Bronze Nut
RN	Roller Nut
SN	Solid Nut



Contact Tolomatic for higher accuracy and lower backlash options.

† (L) for low backlash ball screws: backlash = 0.0020" (0.05 mm)

* For SN & BZ screws, maximum continuous dynamic thrust subject to Thrust x Velocity limitation.

** For RN, BN & BNL screws, dynamic load rating reflects 90% reliability for 1 million revolutions.

§ RSA50 & RSA64 extended stroke length 48" (1219 mm) available for roller screws, contact Tolomatic for production time

RSA HT Electric Rod-Style Actuator



sizeit.tolomatic.com
for fast, accurate
actuator selection

SIZE: **24, 32, 50, 64** units: **metric****

SPECIFICATIONS

** RSA metric actuators use the same leadscrew as the RSA inch actuators. Threaded mounting and dowel pin holes are metric.

RSA SIZE	MAX. STROKE mm	SCREW CODE	LEAD mm/rev	LEAD ACCUR- ACY mm/300mm	BACK- LASH † mm	MAX. THRUST* N	DYNAMIC LOAD RATING** N	BASE ACTUATOR INERTIA			INERTIA PER/in OF STROKE kg-m ² x 10 ⁻⁶	DYNAMIC TORQUE TO OVERCOME FRICTION N-m
								In Line kg-m ² x 10 ⁻⁶	Reverse Parallel			
									1:1 kg-m ² x 10 ⁻⁶	2:1 kg-m ² x 10 ⁻⁶		
24	609.6	RN04	4.00	0.01	0.03	7,562	24,808	207.481	55.016	33.653	1.171	0.599
	609.6	RN05	5.00	0.01	0.03	7,562	24,808	207.481	55.016	33.653	1.171	0.599
	609.6	RN10	10.00	0.01	0.03	6,921	24,808	207.481	55.016	33.653	1.171	0.599
32	914	BZ10	2.54	0.15	0.20	11,121	NA	659.023	98.912	46.822	2.634	0.353
	914	BN(L)02	12.70	0.10	0.38	11,121	14,964	659.023	98.912	46.822	2.926	0.275
	914	BN(L)05	5.08	0.08	0.38	4,226	7,226	659.023	98.912	46.822	2.634	0.261
	914	BNM05	5.00	0.10	0.07	7,971	13,700	659.023	98.912	46.822	2.926	0.633
	914	BNM10	10.00	0.10	0.07	11,000	21,000	659.023	98.912	46.822	2.926	0.633
	914	BNM20	20.00	0.05	0.13	10,516	11,388	659.023	98.912	46.822	3.219	0.633
	914.4	RN04	4.00	0.01	0.03	18,500	56,764	787.784	512.411	229.429	3.219	0.701
	914.4	RN05	5.00	0.01	0.03	17,250	56,764	787.784	512.411	229.429	3.219	0.701
50	1219	BZ10	2.54	0.15	0.20	15,569	NA	1912.980	592.886	246.695	10.242	0.466
	1219	BN(L)01	25.40	0.10	0.38	10,231	10,231	1912.980	592.886	246.695	10.242	0.466
	1219	BN(L)02	12.70	0.10	0.38	18,905	23,820	1912.980	592.886	246.695	8.487	0.410
	1219	BN(L)04	6.35	0.10	0.38	14,457	22,949	1912.980	592.886	246.695	8.194	0.480
	1219	BNM05	5.00	0.05	0.10	10,440	17,947	1912.980	592.886	246.695	7.609	0.847
	1219	BNM10	10.00	0.05	0.10	10,992	14,999	1912.980	592.886	246.695	7.609	0.847
	1219	BNM25	25.00	0.10	0.13	11,227	11,285	1912.980	592.886	246.695	7.609	0.847
	914.4 [§]	RN05	5.00	0.01	0.03	34,999	72,262	2069.542	2885.127	1281.466	17.558	0.960
	914.4 [§]	RN10	10.00	0.01	0.03	34,999	72,262	2069.542	2885.127	1281.466	17.558	0.960
64	1524	BZ10	2.54	0.15	0.20	31,138	NA	4782.305	3973.451	2244.540	40.677	0.614
	1524	BN(L)53	47.93	0.10	0.38	15,569	26,516	4782.305	3973.451	2244.540	52.675	1.661
	1524	BN(L)02	12.70	0.10	0.38	40,257	50,719	4782.305	3973.451	2244.540	41.555	0.600
	1524	BN(L)04	6.35	0.10	0.38	18,905	30,010	4782.305	3973.451	2244.540	40.969	0.607
	1524	BNM05	5.00	0.05	0.10	17,375	29,865	4782.305	3973.451	2244.540	49.749	1.062
	1524	BNM10	10.00	0.05	0.10	24,372	33,253	4782.305	3973.451	2244.540	49.749	1.062
	1524	BNM20	20.00	0.05	0.13	22,708	24,592	4782.305	3973.451	2244.540	49.749	1.062
	1524	BNH(L)02	12.70	0.10	0.38	57,382	72,297	4782.305	3973.451	2244.540	40.969	1.062
	914.4 [§]	RN05	5.00	0.01	0.03	58,000	106,059	4782.305	3973.451	2244.540	36.580	1.062
	914.4 [§]	RN10	10.00	0.01	0.03	53,366	106,553	4782.305	3973.451	2244.540	36.580	1.062

SCREW CODE	DESCRIPTION
BN	Ball Nut
BNH	Ball Nut H-series
BNL	Low-Backlash Ball Nut
BNM	Ball Nut Metric
BZ	Bronze Nut
RN	Roller Nut
SN	Solid Nut



Contact Tolomatic for higher accuracy and lower backlash options.
† (L) for low backlash ball screws: backlash = 0.0020" (0.05 mm)

* For SN & BZ screws, maximum continuous dynamic thrust subject to Thrust x Velocity limitation.

** For RN, BN & BNL screws, dynamic load rating reflects 90% reliability for 1 million revolutions.

§ RSA50 & RSA64 extended stroke length 48" (1219 mm) available for roller screws, contact Tolomatic for production time

RSA-HT

RSA HT Electric Rod-Style Actuator

sizeit.tolomatic.com
for fast, accurate
actuator selection

SIZE: 24: CRITICAL SPEED CAPACITIES

SPECIFICATIONS

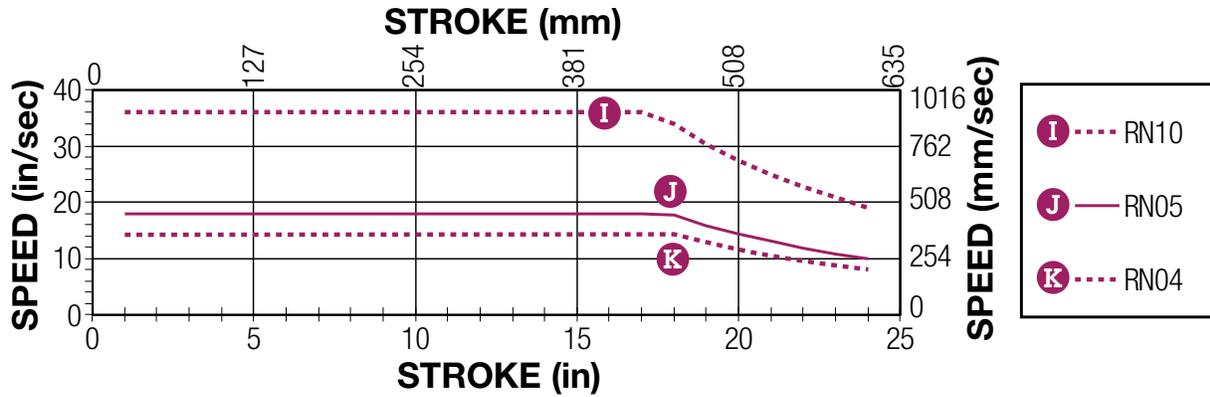

SIZE: 32: CRITICAL SPEED CAPACITIES

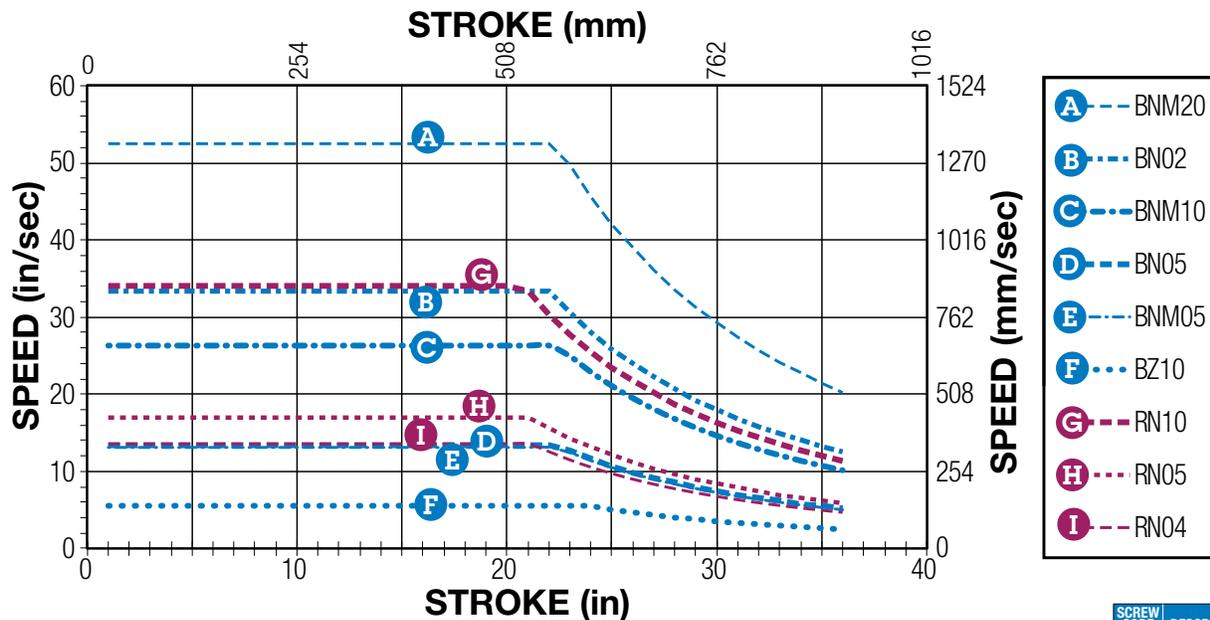

SCREW CODE	DESCRIPTION
BN	Ball Nut
BNH	Ball Nut H-series
BNL	Low-Backlash Ball Nut
BNM	Ball Nut Metric
BZ	Bronze Nut
RN	Roller Nut
SN	Solid Nut

SIZE: 50: CRITICAL SPEED CAPACITIES

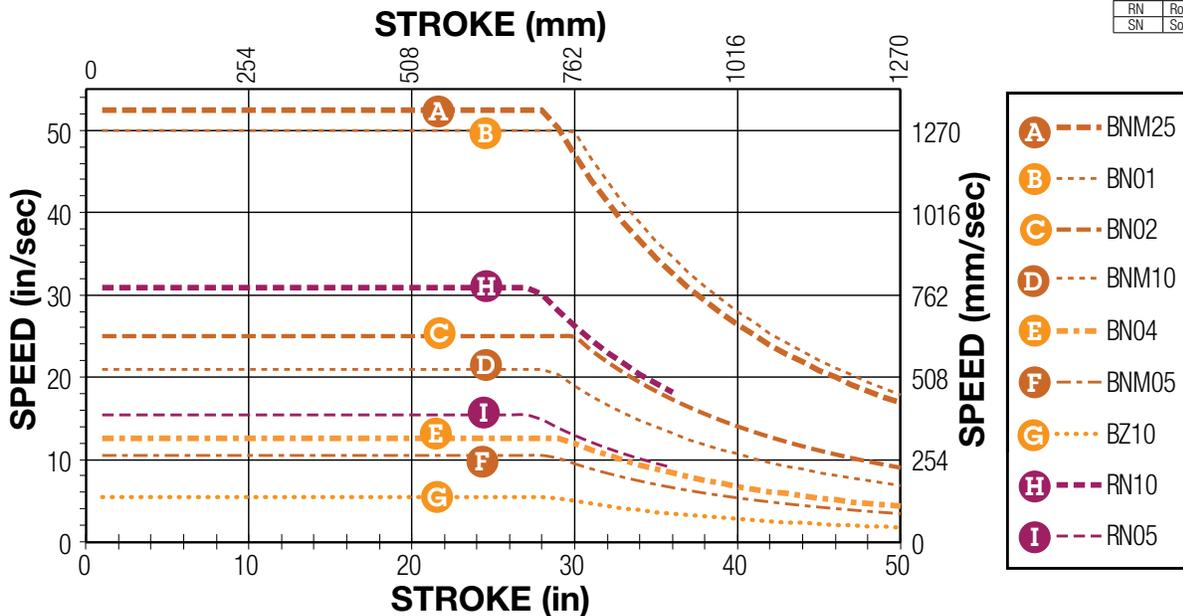

RSA-HT

RSA HT Electric Rod-Style Actuator

sizeit.tolomatic.com
for fast, accurate
actuator selection

SIZE: **64: CRITICAL SPEED CAPACITIES**

SPECIFICATIONS

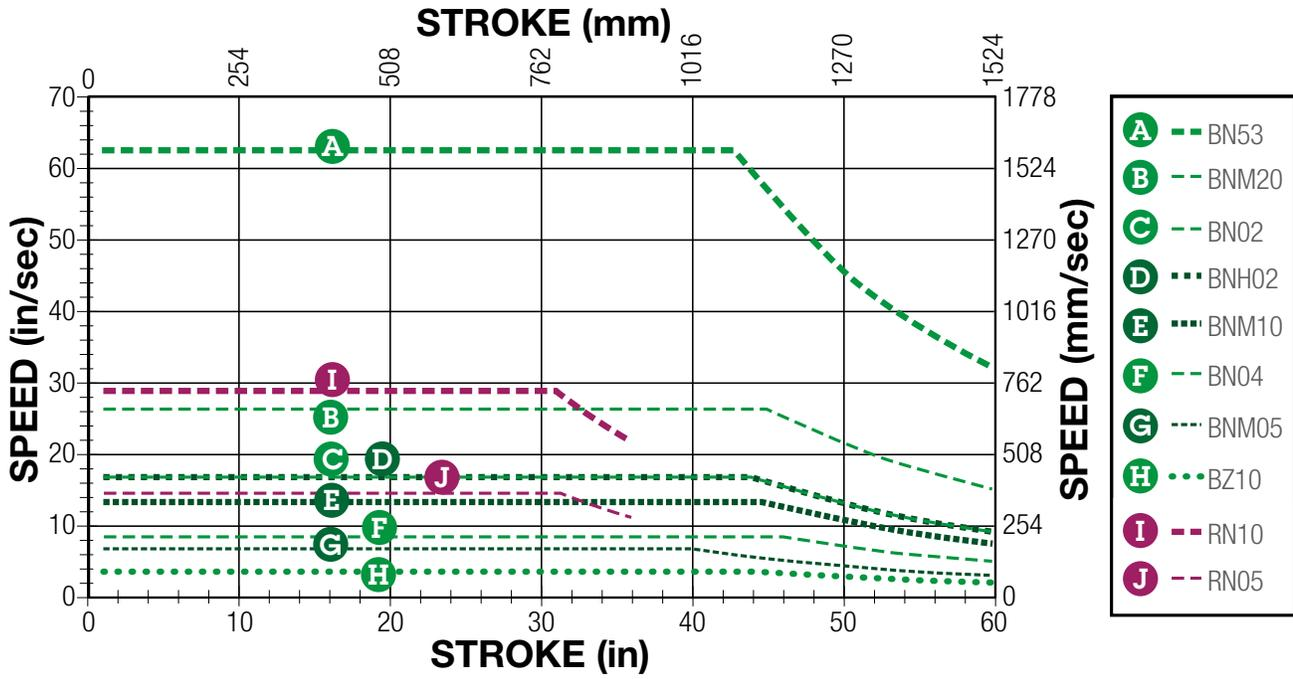

SIZE: **32,50,64 (BZ): PV LIMITS (Bronze Nuts)**

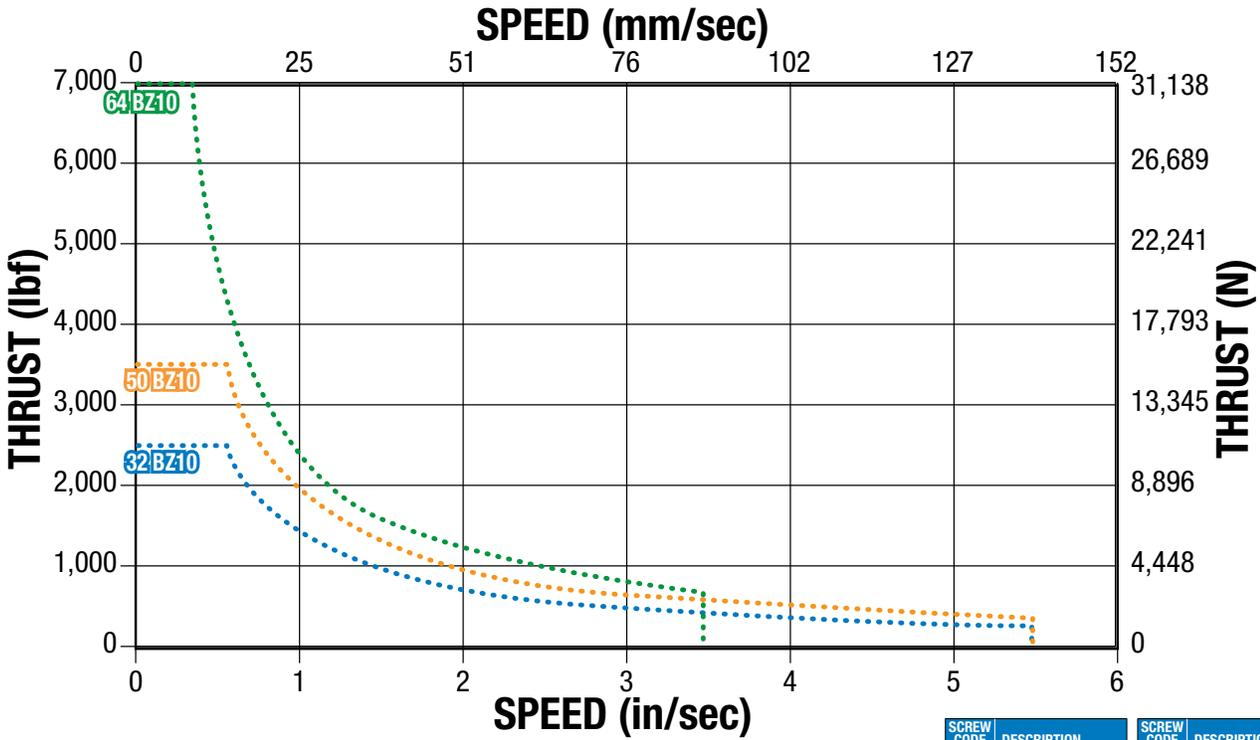

PV LIMITS

PV LIMITS: Any material which carries a sliding load is limited by heat buildup. The factors that affect heat generation rate in an application are the pressure on the nut in pounds per square inch and the surface velocity in feet per minute. The product of these factors provides a measure of the severity of an application.

$$P \times V \leq 0.1$$

$$\left(\frac{\text{Thrust}}{\text{(Max. Thrust Rating)}} \right) \times \left(\frac{\text{Speed}}{\text{(Max. Speed Rating)}} \right) \leq 0.1$$

SCREW CODE	DESCRIPTION	SCREW CODE	DESCRIPTION
BN	Ball Nut	BZ	Bronze Nut
BNH	Ball Nut H-series	RN	Roller Nut
BNL	Low-Backlash Ball Nut	SN	Solid Nut
BNM	Ball Nut Metric		

RSA-HT

RSA HT Electric Rod-Style Actuator

sizeit.tolomatic.com
for fast, accurate
actuator selection

BALL & ROLLER SCREW LIFE GRAPHS

SPECIFICATIONS

SIZE: 24, 32

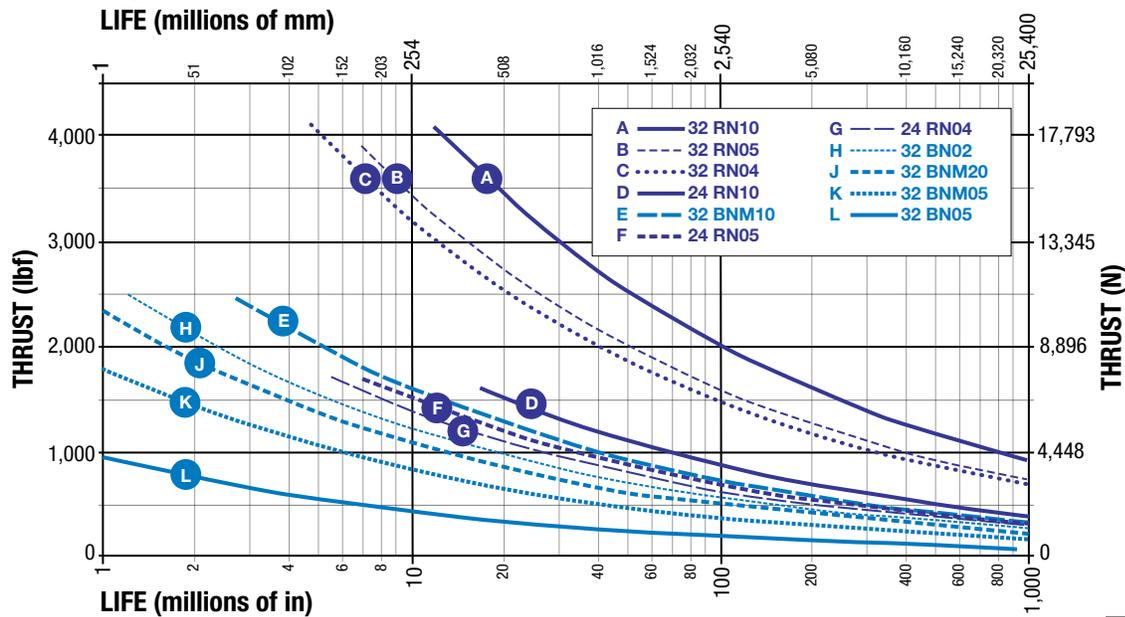

SCREW CODE	DESCRIPTION
BN	Ball Nut
BNH	Ball Nut H-series
BNL	Low-Backlash Ball Nut
BNM	Ball Nut Metric
BZ	Bronze Nut
RN	Roller Nut
SN	Solid Nut

SIZE: 50, 64

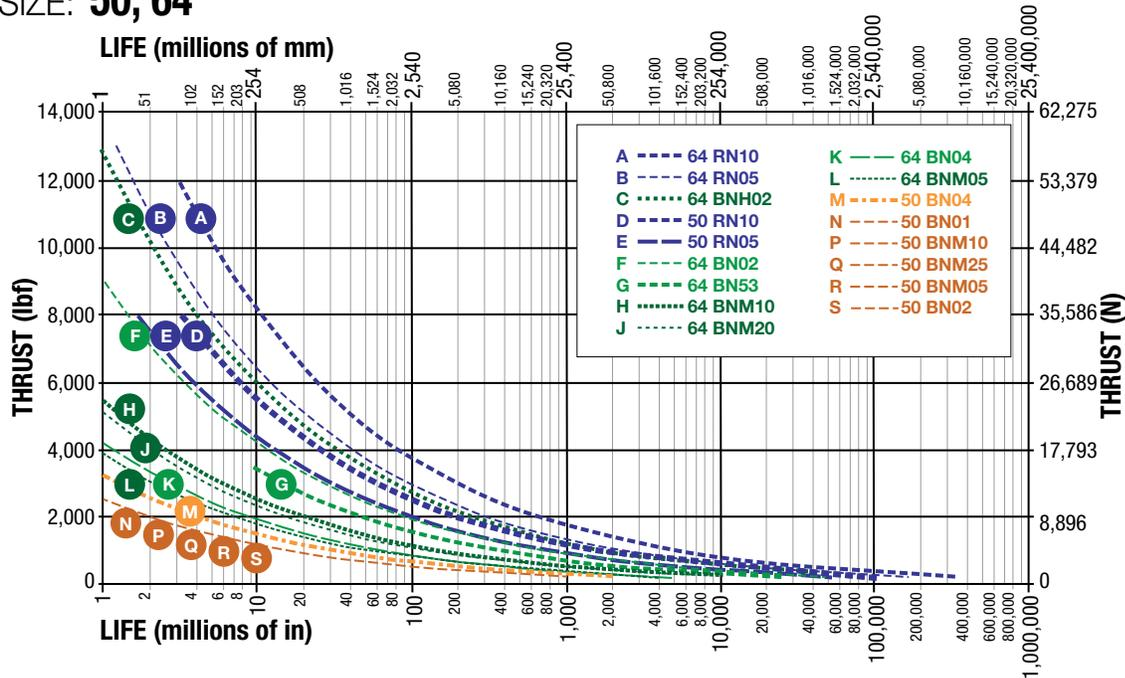

NOTE: The L_{10} expected life of a ball screw linear actuator is expressed as the linear travel distance that 90% of properly maintained ball screw manufactured are expected to meet or exceed. This is not a guarantee and this graph should be used for estimation purposes only.

The underlying formula that defines this value is:

$$L_{10} = \left(\frac{C}{P_e} \right)^3 \cdot \ell =$$

L_{10} Travel life in millions of units (in or mm), where:

C = Dynamic load rating (lbf) or (N)

P_e = Equivalent load (lbf) or (N)

If load is constant across all movements then:

actual load = equivalent load

ℓ = Screw lead (in/rev) (mm/rev)

Use the "Equivalent Load" calculation below, when the load is not constant throughout the entire stroke. In cases where there is only minor variation in loading, use greatest load for life calculations.

Where:
$$P_e = \sqrt[3]{\frac{L_1(P_1)^3 + L_2(P_2)^3 + L_3(P_3)^3 + L_n(P_n)^3}{L}}$$

P_e = Equivalent load (lbf) or (N)

P_n = Each increment at different load (lbf) or (N)

L = Total distanced traveled per cycle (extend + retract stroke)
[L = L₁ + L₂ + L₃ + L_n]

L_n = Each increment of stroke at different load (in) or (mm)

RSA HT Electric Rod-Style Actuator

sizeit.tolomatic.com
for fast, accurate
actuator selection

SCREW BUCKLING LOAD

SPECIFICATIONS

SIZE: 24, 32

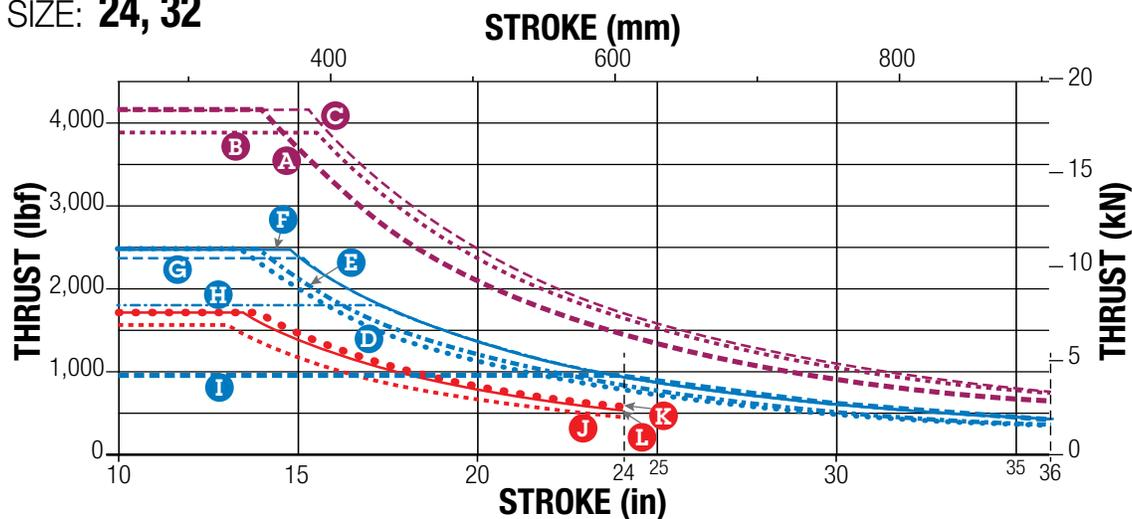

SIZE: 50

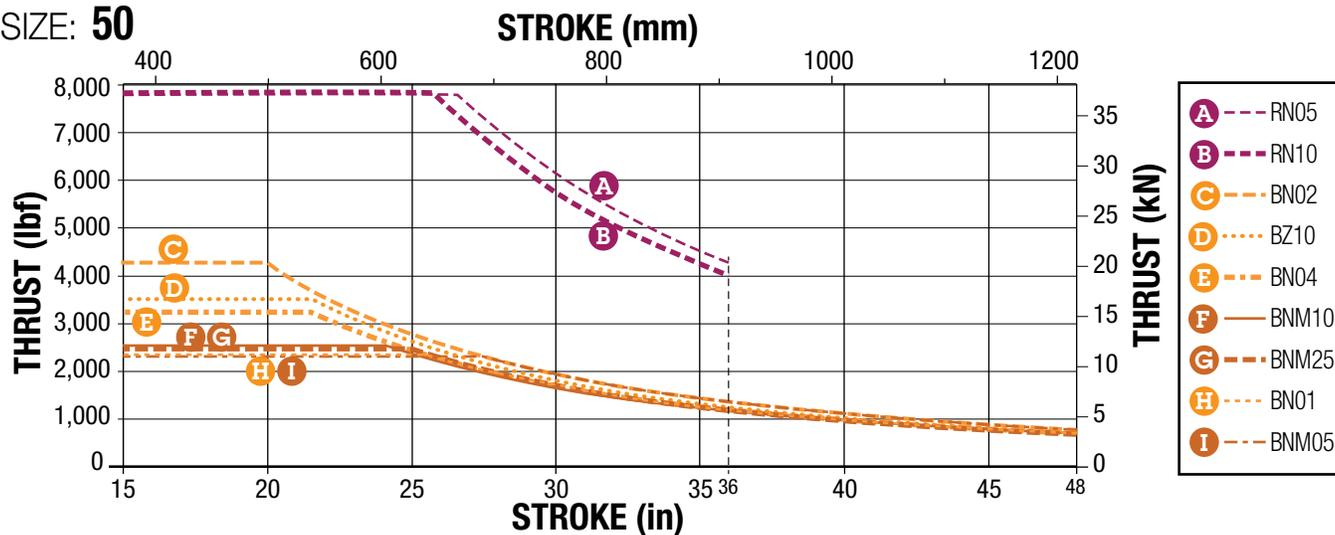

SIZE: 64

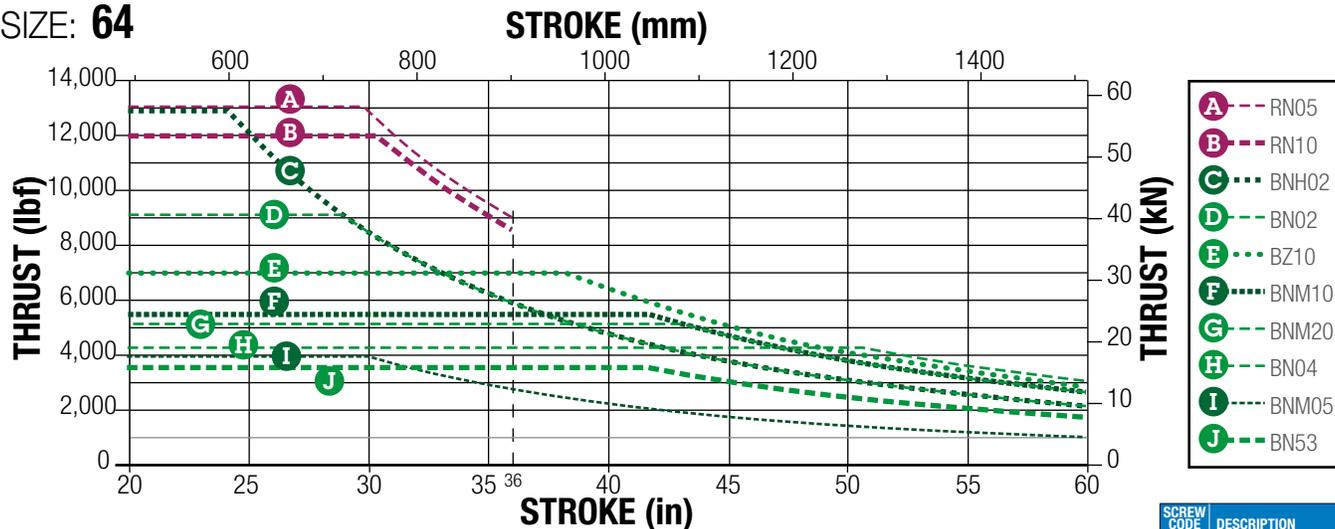

NOTE: Buckling load limits shown assume perfect alignment. It is recommended to use additional safety margin, particularly in high thrust applications

SCREW CODE	DESCRIPTION
BN	Ball Nut
BNH	Ball Nut H-series
BNL	Low-Backlash Ball Nut
BNM	Ball Nut Metric
BZ	Bronze Nut
RN	Roller Nut
SN	Solid Nut

RSA-HT

RSA HT Electric Rod-Style Actuator

SIZE: 24, 32, 50, 64

SPECIFICATIONS



sizeit.tolomatic.com
for fast, accurate
actuator selection

RSA SIZE			24	32			50			64			
			RN	BZ	BN	RN	BZ	BN	RN	BZ	BN	RN	
WEIGHT	BASE MODEL	IN-LINE	lb	3.98	12.76	12.76	17.29	20.58	20.58	22.08	38.10	38.10	40.06
		REVERSE PARALLEL	lb	6.25	12.01	12.01	20.36	25.32	25.32	26.82	44.43	44.43	46.39
	PER in OF STROKE	lb/in	0.330	0.460	0.460	0.473	0.860	0.860	0.950	1.380	1.380	1.325	
MOVING PARTS WEIGHT	BASE WT.	lb	1.64	0.97	1.44	3.15	2.62	3.55	6.77	5.01	7.59	12.88	
	PER in OF STROKE	lb/in	0.14	0.15	0.15	0.15	0.3	0.3	0.3	0.45	0.45	0.45	
MAX. STROKE			in	24.0	36.0	36.0	36.0	48.0	48.0	36.0	60.0	60.0	36.0
TEMP. RANGE*			°F	Standard: 40 to 130 Extended: -40 to 140									



Contact Tolomatic if operation in the extended range is required.

RSA SIZE			24	32			50			64			
			RN	BZ	BN	RN	BZ	BN	RN	BZ	BN	RN	
WEIGHT	BASE MODEL	IN-LINE	kg	1.79	5.79	5.79	7.84	9.33	9.33	10.01	17.28	17.28	18.17
		REVERSE PARALLEL	kg	2.81	5.45	5.45	9.17	11.40	11.40	12.08	20.15	20.15	21.04
	PER mm OF STROKE	g/mm	5.8	8.1	8.1	8.4	15.2	15.2	16.8	24.4	24.4	23.4	
MOVING PARTS WEIGHT	BASE WT.	kg	0.74	0.44	0.65	1.43	1.19	1.61	3.07	2.27	3.44	5.84	
	PER mm OF STROKE	g/mm	2.50	2.68	2.68	2.68	5.36	5.36	5.36	8.04	8.04	8.04	
MAX. STROKE			mm	609.6	914.4	914.4	914.4	1219.2	1219.2	914.4	1524	1524	914.4
TEMP. RANGE*			°C	Standard: 4 to 54 Extended: -40 to 60									

Gasket Kit providing ingress protection against dust and splashing water available upon request



Contact Tolomatic if operation in the extended range is required.



* Heat generated by the motor and drive should be taken into consideration as well as linear velocity and work cycle time. For applications that require operation outside of the recommended temperature range, contact Tolomatic.

LARGE FRAME MOTORS AND SMALLER SIZE ACTUATORS: Cantilevered motors need to be supported, if subjected to continuous rapid reversing duty and/or under dynamic conditions.

SIDE LOADING CONSIDERATIONS: Rod screw actuators are designed to push guided and supported loads and are not meant for applications that require substantial side loading. Please contact Tolomatic for details regarding side loading capabilities.

RSA HT Electric Rod-Style Actuator



sizeit.tolomatic.com
for fast, accurate
actuator selection

SIZE: **24, 32, 50, 64**

SPECIFICATIONS

RE-LUBRICATION RECOMMENDATION:

RSA-HT Lubrication requirements for electric actuators depend on the motion cycle (velocity, force, duty cycle), type of application, ambient temperature, environmental surrounding and various other factors.

For many general purpose applications, Tolomatic ball screw actuators are typically considered lubricated for life unless otherwise specified, such as those actuator models outfitted with a re-lubrication feature. For roller screw or ball screw actuators outfitted with a re-lubrication feature, Tolomatic recommends to re-lubricate the actuator at least once per year or every 1,000,000 cycles, whichever comes first, to maximize service life. For more demanding applications such as pressing,

high frequency or other highly stressed applications, the re-lubrication interval for these actuators will vary and will need to be more frequent. In these demanding applications, it is recommended to execute at least 5 full stroke moves every 5,000 cycles of operation (or more frequent if possible) to re-distribute the grease within the actuator.

Re-lubricate with Tolomatic Grease into the grease zerk located on the rod end.

	RSA24	RSA32	RSA50	RSA64
Qty.	2.5g + (0.010x §mm)	4.8g + (0.010x §mm)	5.3g + (0.018x §mm)	6.6g + (0.018x §mm)
Qty.	0.09oz + (0.009x §in)	0.17oz + (0.009x §in)	0.19oz + (0.016x §in)	0.23oz + (0.016x §in)

§ = Stroke length (mm or in)



In some applications oil may leak from the grease zerk. In contamination sensitive applications replace grease zerk with plug.



GREASE ZERK

- This relubrication system provides extended screw service life
- Convenient lubrication without disassembly
- Standard with all HT option RSA actuators
- Grease zerk orientation is not pre-defined. Custom orientation can be requested as a product modification

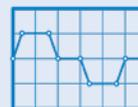

sizeit.tolomatic.com
for fast, accurate
actuator selection



tolomatic.com/ask
Technical support
before and after
purchase

RSA-HT

RSA HT Electric Rod-Style Actuator

SIZE: 24,32,50,64

DIMENSIONS

tolomatic.com/CAD Download 3D CAD Always use CAD solid model to determine critical dimensions



HT ACTUATOR DIMENSIONS

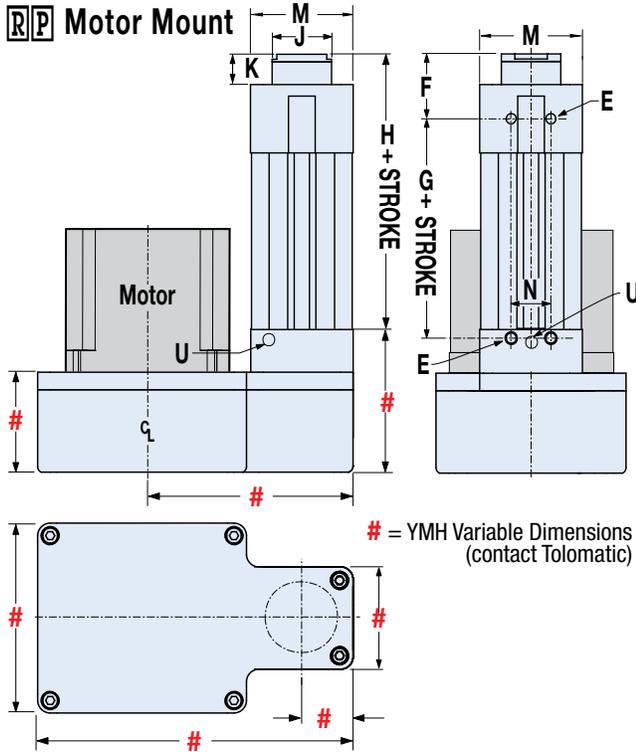
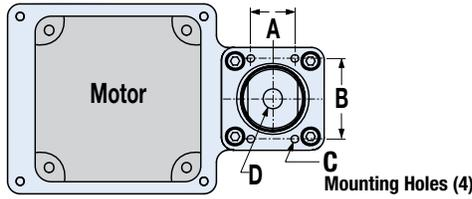

RSA32 HT, RSA50 HT, RSA64 HT

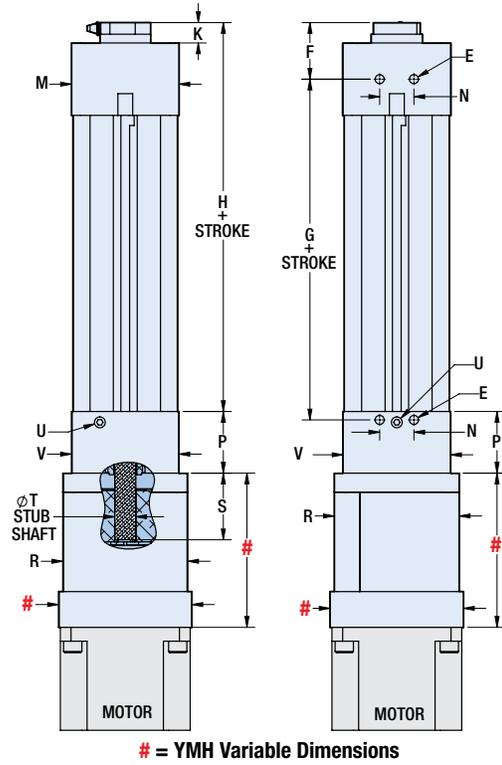
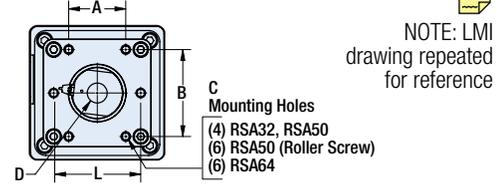

		F	G	H	K	L	M	N	P	R	S	T	U	V	
RSA32	RN	in	1.44	5.92	6.24	0.50	--	2.58	0.95	3.50	3.25	1.70	0.625	1/16-27 NPT	3.25
		mm	36.5	150.4	158.4	12.7	--	65.5	24.1	88.9	82.6	43.2	15.88	1/16-27 NPT	82.6
	BN	in	1.44	5.05	6.24	0.50	--	2.58	0.95	1.79	3.25	1.75	0.530	1/16-27 NPT	2.58
		mm	36.5	128.3	158.4	12.7	--	65.5	24.1	45.4	82.6	44.5	13.46	1/16-27 NPT	65.5
	BZ	in	1.44	3.87	5.06	0.50	--	2.58	0.95	1.79	3.25	1.75	0.530	1/16-27 NPT	2.58
		mm	36.5	96.4	128.4	12.7	--	65.5	24.1	45.4	82.6	44.5	13.46	1/16-27 NPT	65.5
RSA50	RN	in	1.95	7.21	8.41	0.70	3.00	3.71	1.81	3.80	4.31	2.31	0.729	1/8-27 NPT	3.71
		mm	49.5	183.1	213.6	17.8	76.2	94.1	30.0	96.5	109.5	58.7	18.52	1/8-27 NPT	94.2
	BN	in	1.95	5.78	7.44	0.70	--	3.71	1.81	2.13	4.31	2.30	0.730	1/8-27 NPT	3.71
		mm	49.5	146.9	189.0	17.8	--	94.1	30.0	54.0	109.5	58.4	18.54	1/8-27 NPT	94.2
	BZ	in	1.95	4.78	6.44	0.70	--	3.71	1.81	2.13	4.31	2.30	0.730	1/8-27 NPT	3.71
		mm	49.5	121.5	163.6	17.8	--	94.1	30.0	54.0	109.5	58.4	18.54	1/8-27 NPT	94.2
RSA64	RN	in	2.37	7.80	9.29	0.68	3.50	4.58	1.97	4.25	5.60	2.67	0.999	1/8-27 NPT	4.58
		mm	60.1	196.0	235.9	17.3	88.9	116.3	50.0	108.0	142.2	67.9	25.38	1/8-27 NPT	116.3
	BN	in	2.37	10.25	11.74	0.68	3.50	4.58	1.97	4.25	5.60	2.67	0.999	1/8-27 NPT	4.58
		mm	60.1	260.3	298.2	17.3	88.9	116.3	50.0	108.0	142.2	67.9	25.38	1/8-27 NPT	116.3
	BZ	in	2.37	7.80	9.29	0.68	3.50	4.58	1.97	4.25	5.60	2.67	0.999	1/8-27 NPT	4.58
		mm	60.1	198.0	235.9	17.3	88.9	116.3	50.0	108.0	142.2	67.9	25.38	1/8-27 NPT	116.3

NOTE: See previous page for additional dimensions

See page 18 for additional RP mounting codes

RSA-HT

RSA HT Rod End Options

SIZE: 24, 32, 50, 64

DIMENSIONS

tolomatic.com/CAD Download 3D CAD Always use CAD solid model to determine critical dimensions



SRE SPHERICAL ROD END

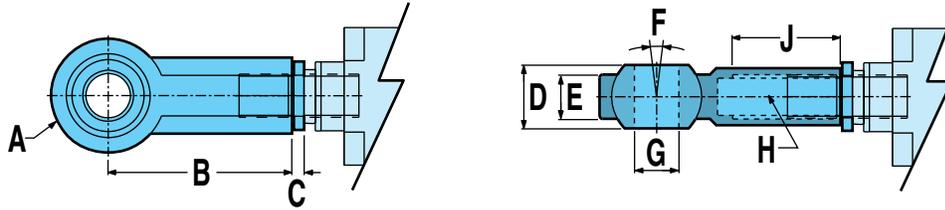

Allows for slight misalignment between the load and the actuator (radial and angular). Uses an industry-standard bearing.

Size		A Ø	B	C	D	E	F	G Ø	H	J
24	in	1.125	1.812	0.15	0.560	0.437	10°	0.438	7/16-20	1.06
	mm	28.00	43.00	3.8	14.00	10.50		10.00	M10x1.25	20.0
32	in	1.125	1.812	0.15	0.560	0.437		0.437	7/16-20	1.06
	mm	42.00	64.00	4.8	21.00	15.00		16.00	M16x1.5	28.0
50	in	1.750	2.875	0.19	0.875	0.687		0.750	3/4-16	1.75
	mm	50.00	77.00	4.8	25.00	18.00		20.00	M20x1.5	33.0
64	in	2.750	4.125	0.19	1.375	1.000		1.00	1-1/4-12	2.13
	mm	70.00	110.00	6.4	37.00	25.00		30.00	M27x2.0	51.0

CLV CLEVIS ROD END

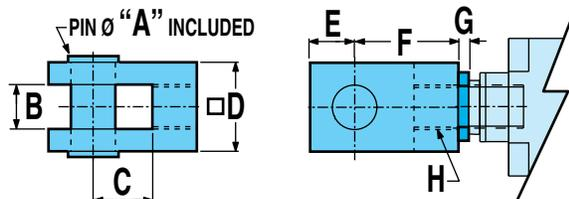

Used with the externally threaded rod end when the actuator has to compensate for misalignment or pivot about an axis.

Size		A Ø	B	C	D	E	F	G	H
24	in	0.50	0.51	0.75	1.00	0.50	1.375	0.15	7/16-20
	mm	10.0	10.0	20.0	20.0	16.0	40.00	3.8	M10x1.25
32	in	0.50	0.51	0.75	1.00	0.50	1.375	0.15	7/16-20
	mm	16.0	16.0	32.0	32.0	19.0	64.00	4.8	M16x1.5
50	in	0.75	0.75	1.00	1.50	0.75	1.750	0.19	3/4-16
	mm	20.0	20.0	40.0	40.0	25.0	80.00	4.8	M20x1.5
64	in	1.375	2.03	1.75	4.03	1.38	3.750	0.19	1-1/4-12
	mm	30.0	30.0	54.0	55.0	45.0	110.00	6.4	M27x2.0

KEY TO SYMBOLS

- ▲ Indicates a note of high importance
- ⊗ Indicates incompatibility with option(s) or size(s)
- 📝 Make note of this item

RSA HT Rod End Options

SIZE: 24, 32, 50, 64

DIMENSIONS

tolomatic.com/CAD Download 3D CAD Always use CAD solid model to determine critical dimensions



MET EXTERNALLY THREADED ROD END



An alternative to the standard internally threaded end.

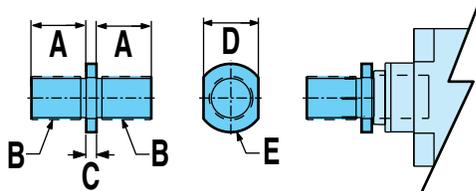

Size		A	B	C	D	E Ø
24	in	0.87	7/16-20	0.15	0.750	0.97
	mm	22.1	M10x1.25	3.8	19.00	24.6
32	in	0.87	7/16-20	0.15	0.750	0.97
	mm	28.0	M16x1.5	4.8	19.00	24.6
50	in	1.50	3/4-16	0.19	1.250	1.48
	mm	38.1	M-20x1.5	4.8	32.00	37.6
64	in	2.13	1-1/4-12	0.19	1.313	1.60
	mm	50.8	M27x2	6.4	32.00	38.1

ALC ALIGNMENT COUPLER

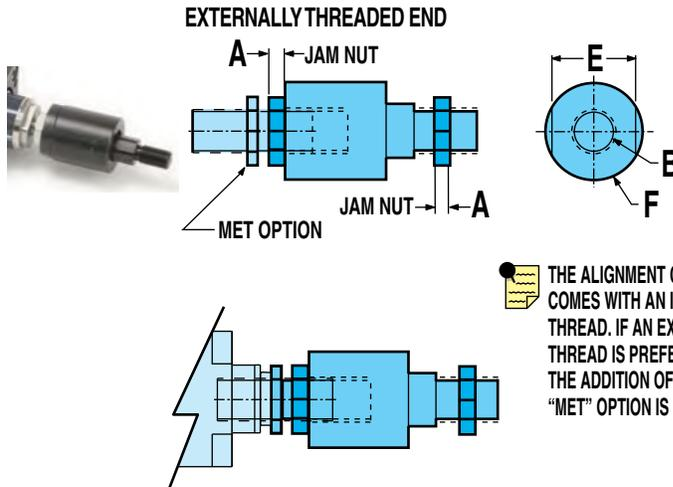
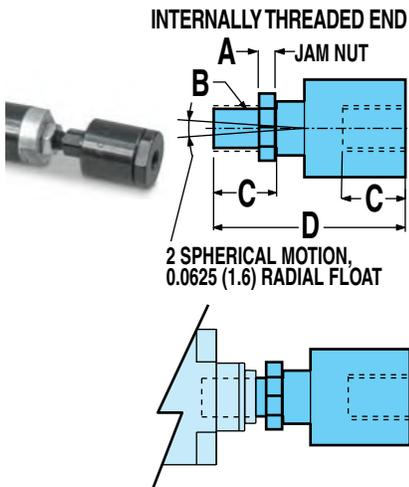

Size		A	B	C	D	E	F
24	in	0.25	7/16-20	0.75	2.75	1.13	1.25
	mm	6.4	M10x1.25	24.0	77.0	19.0	30.0
32	in	0.25	7/16-20	0.75	2.75	1.13	1.25
	mm	8.0	M16x1.5	32.0	106.0	30.0	42.0
50	in	0.45	3/4-16	1.13	3.44	1.50	1.75
	mm	10.0	M20x1.5	42.0	122.0	30.0	42.0
64	in	0.50	1-1/4-12	1.63	4.56	2.25	2.50
	mm	13.5	M27x2.0	54.0	147.0	32.0	55.0

Used in combination with the externally threaded rod end to provide smooth motion and extends actuator life by preventing binding caused by angular or axial misalignment. Not available for use with clevis or trunnion mounts, as they must be rigidly mounted.

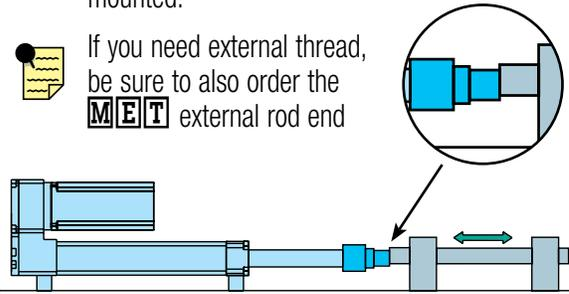

RSA-HT

RSA HT Mounting Options

SIZE: 24, 32, 50, 64

DIMENSIONS

tolomatic.com/CAD Download 3D CAD Always use CAD solid model to determine critical dimensions



FFG FRONT FLANGE MOUNT



Used when a bottom-tapped mount is not an option or where bottom support mechanisms are not feasible.

Flange can be mounted directly to framework or a bulkhead

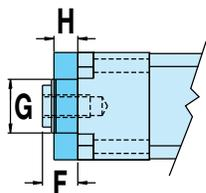
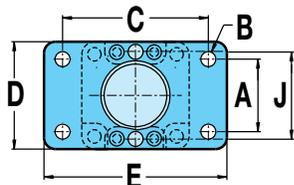

Size		A	B Ø	C	D	E	F	G Ø	H	J
24	in	1.430	0.31	2.750	2.00	3.37	0.80	1.34	0.37	–
	mm	32.00	7.2	64.00	47.0	80.0	20.4	34.0	10.0	–
32	in	1.840	0.37	3.375	2.50	4.12	0.87	1.50	0.37	–
	mm	45.00	9.2	90.00	65.0	113.0	22.1	34.0	12.0	–
50	in	2.760	0.43	4.687	3.75	5.50	1.32	1.90	0.62	–
	mm	63.00	12.2	126.00	97.0	153.0	33.5	48.3	16.0	–
64	in	3.320	0.58	8.000	4.50	9.00	1.48	2.40	0.80	3.50
	mm	84.33	14.7	203.2	114.3	228.6	37.6	61.0	20.3	88.9



See page 22 for additional FFG mount codes

M P 2 MOUNTING PLATE

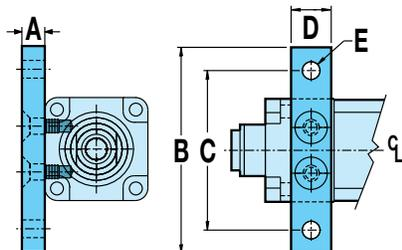

Used for mountings other than flush.

Size		A	B	C	D	E Ø
24	in	0.50	3.50	2.75	1.50	0.44
	mm	12.0	78.0	62.0	25.4	6.7
32 BN	in	0.50	4.00	3.25	1.50	0.44
	mm	12.0	104.0	84.0	31.8	8.7
32 RN	in	0.50	4.00	3.25	1.50	0.44
	mm	12.0	104.0	84.0	31.8	8.7
50 BN	in	0.75	5.75	4.75	1.75	0.56
	mm	20.0	144.0	120.0	30.5	11.0
50 RN	in	1.25	5.75	4.75	1.75	0.56
	mm	31.8	146.1	120.0	44.5	11.0
64	in	1.25	6.50	5.50	1.75	0.56
	mm	31.8	180.0	150.0	44.5	12.8

KEY TO SYMBOLS

- Indicates a note of high importance
- Indicates incompatibility with option(s) or size(s)
- Make note of this item

RSA HT Mounting Options

SIZE: 24, 32, 50, 64

DIMENSIONS

tolomatic.com/CAD Download 3D CAD Always use CAD solid model to determine critical dimensions



T R R TRUNNION MOUNT



Used where space is limited in the rear of the actuator and when pivoting about an axis is required.

RSA US standard (Sizes: 24, 32, 50, 64)

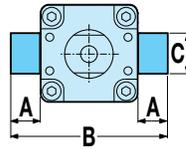

Both RSA US standard RSM Metric

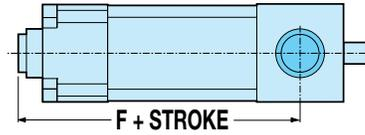

RSA: US standard	Size	A	B	C Ø	D Ø	E	F (LMI)			F (RP)		
							ACME NUT	BALL NUT	ROLLER NUT	ACME NUT	BALL NUT	ROLLER NUT
							24	in	1.04	4.12	0.9999/0.9993	NA
32	in	1.00	4.58	0.9999/0.9993	NA	NA	6.06	7.24	7.42	5.65	6.83	7.42
50	in	1.06	5.83	0.9999/0.9993	NA	NA	7.44	8.44	9.07	7.14	8.14	9.07
64	in	1.25	7.92	0.9999/0.9993	1.50	0.42	10.29	12.74	10.29	10.29	12.74	10.29

RSM: Metric	Size	A	B	C Ø	D Ø	E	F (LMI)			F (RP)		
							ACME NUT	BALL NUT	ROLLER NUT	ACME NUT	BALL NUT	ROLLER NUT
							24	mm	8.6	75.7	11.96/11.99	18.0
32	mm	16.0	107.0	15.95/15.98	25.0	4.74	153.8	183.8	188.5	143.5	173.5	188.5
50	mm	20.1	150.1	19.95/19.98	30.0	7.9	191.0	214.4	230.3	181.3	206.7	230.3
64	mm	24.9	181.9	24.97/24.99	40.0	7.9	261.3	323.6	261.3	261.3	323.6	261.3

B F G BACK FLANGE MOUNT

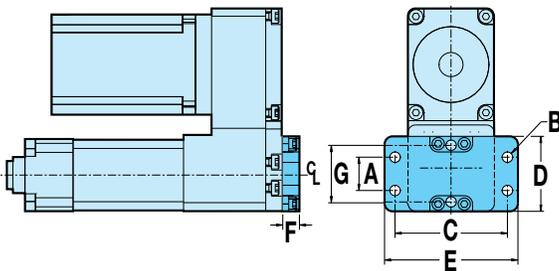

Used when a bottom-tapped mount is not an option or where bottom support mechanisms are not feasible. Flange can be mounted directly to framework or a bulkhead

⊗ Not available with LMI (inline) motor mounting

Size		A	B Ø	C	D	E	F	G
24	in	1.430	0.31	2.750	2.00	3.37	0.37	—
	mm	32.00	7.2	64.00	47.0	80.0	9.40	—
32	in	1.840	0.37	3.375	2.50	4.12	0.37	—
	mm	45.00	9.2	90.00	65.0	113.0	9.40	—
32 RN	in	1.840	0.37	4.000	2.50	4.75	0.37	—
	mm	45.00	9.2	101.60	65.0	120.7	9.40	—
50	in	2.760	0.43	4.687	3.75	5.50	0.62	—
	mm	63.00	12.2	126.00	97.0	153.0	15.7	—
50 RN	in	2.760	0.43	7.000	3.75	8.00	0.62	3.00
	mm	63.00	12.2	177.80	97.0	203.2	15.7	76.2
64	in	3.320	0.58	8.000	4.50	9.00	0.62	3.50
	mm	75.00	14.7	203.2	114.3	228.6	15.7	88.9



See page 22 for additional BFG mount codes

RSA HT Mounting Options

SIZE: 24, 32, 50, 64

DIMENSIONS

tolomatic.com/CAD Download 3D CAD Always use CAD solid model to determine critical dimensions



PCS EYE MOUNT & PCD CLEVIS MOUNT



Used when the actuator has to compensate for misalignment or pivot about an axis when free movement is available in the back of the actuator.

✘ Not available with LMI (inline) motor mounting



Used when the actuator has to compensate for misalignment or pivot about an axis when free movement is available in the back of the actuator.

✘ Not available with LMI (inline) motor mounting.

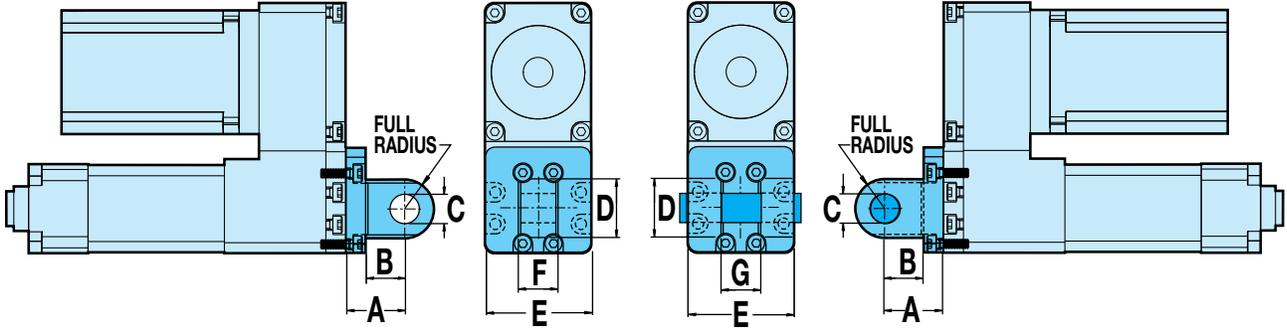

Size		A	B	C Ø	D	E	F	G
24	in	1.062	0.687	0.501 / 0.500	1.00	1.98	0.750 / 0.745	0.755 / 0.751
	mm	22.00	12.00	10.03 / 10.00	20.0	50.2	25.80 / 25.60	26.12 / 26.01
32	in	1.062	0.687	0.501 / 0.500	1.00	2.58	0.750 / 0.745	0.755 / 0.751
	mm	27.00	15.00	12.03 / 12.00	26.0	65.5	31.80 / 31.60	32.12 / 32.01
50	in	1.875	1.375	0.751 / 0.750	1.50	3.60	1.250 / 1.245	1.255 / 1.251
	mm	36.00	20.00	16.03 / 16.00	40.0	91.5	49.80 / 49.60	50.12 / 50.01
64	in	2.335	1.535	1.003 / 1.002	2.00	4.48	1.500 / 1.495	1.505 / 1.501
	mm	59.31	38.99	28.03 / 28.00	50.8	113.7	39.90 / 39.80	40.10 / 40.00



See page 25 for additional PCS and PCD mount codes

KEY TO SYMBOLS

- ▲ Indicates a note of high importance
- ✘ Indicates incompatibility with option(s) or size(s)
- 📄 Make note of this item

RSA HT Mounting Options

SIZE: 24, 32, 50, 64

DIMENSIONS

tolomatic.com/CAD Download 3D CAD Always use CAD solid model to determine critical dimensions



XR OPTIONAL ROD EXTENSION

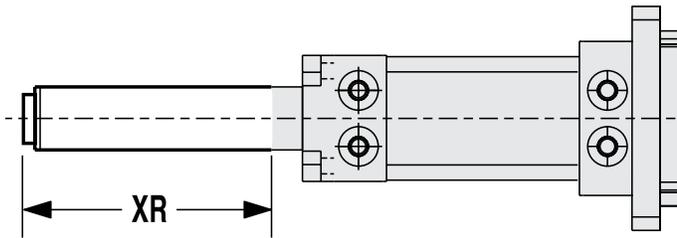

In **vertical applications only**, the thrust rod length can be extended by specifying the rod extension option. This does not increase the working stroke, only the length of the thrust rod.

NOTE: the XR dimension in the configurator string (extension + stroke) should not exceed the maximum stroke of the specified actuator. Consult Tolomatic for extensions greater than the maximum stroke length.

Maximum Stroke Length

Size	All Screws	
24	in	24
	mm	609.6
32	in	36
	mm	914.4
50	in	48
	mm	1219.2
64	in	60
	mm	1524

Z12 ZERK ORIENTATION

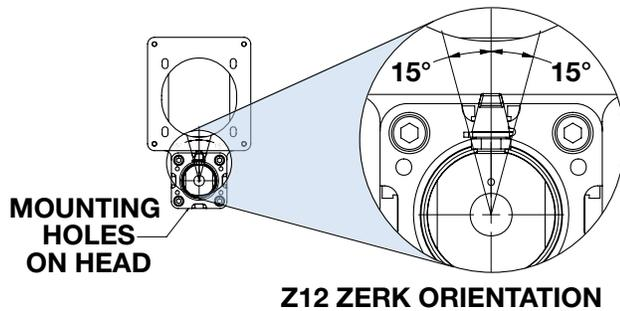

The orientation of the zerk is unspecified unless the Z12 ordering code included in the configuration string

GSA Guided Electric Rod-Style Actuator



sizeit.tolomatic.com
for fast, accurate
actuator selection

SIZE: ALL

units: US standard

SPECIFICATIONS

GSA SIZE	BEARING TYPE	GUIDE ROD in	MAX. STROKE in	SCREW TYPE	TPI turns/in	LEAD ACCURACY† in/ft	BACKLASH in	MAX THRUST* lbf	DYNAMIC LOAD RATING** lbf	BASE ACTUATOR INERTIA			INERTIA PER/in OF STROKE lb-in ²	DYNAMIC FRICTION TORQUE lb-in	MOVING PARTS WEIGHT				
										In Line lb-in ²	Reverse Parallel lb-in ²				Base lb	Per Inch lb			
											1:1	2:1							
12	LINEAR	STANDARD Ø0.50	18	SN01	1	0.010	0.007	70	NA	0.004	0.005	NA	0.002	2.938	1.21	0.14			
			18	SN02	2	0.006	0.007	70	NA	0.002	0.003	NA	0.001	1.500	1.21	0.14			
			18	SN05	5	0.006	0.007	70	NA	0.002	0.002	NA	0.001	0.563	1.21	0.14			
			18	BZ10	10	0.006	0.008	70	NA	0.002	0.002	NA	0.001	0.438	1.21	0.14			
			18	BN(L)08	8	0.003	0.015	130	260	0.002	0.002	NA	0.001	0.500	1.29	0.14			
	COMPOSITE	STANDARD Ø0.50	18	SN01	1	0.010	0.007	70	NA	0.004	0.005	NA	0.002	5.625	1.21	0.14			
			18	SN02	2	0.006	0.007	70	NA	0.002	0.003	NA	0.001	2.813	1.21	0.14			
			18	SN05	5	0.006	0.007	70	NA	0.002	0.002	NA	0.001	1.125	1.21	0.14			
			18	BZ10	10	0.006	0.008	70	NA	0.002	0.002	NA	0.001	0.813	1.21	0.14			
			18	BN(L)08	8	0.003	0.015	130	260	0.002	0.002	NA	0.001	0.688	1.29	0.14			
		OVERSIZED Ø0.63	18	SN01	1	0.010	0.007	70	NA	0.004	0.005	NA	0.002	6.125	1.56	0.20			
			18	SN02	2	0.006	0.007	70	NA	0.002	0.003	NA	0.001	3.063	1.56	0.20			
			18	SN05	5	0.006	0.007	70	NA	0.002	0.002	NA	0.001	1.250	1.56	0.20			
			18	BZ10	10	0.006	0.008	70	NA	0.002	0.002	NA	0.001	0.938	1.56	0.20			
			18	BN(L)08	8	0.003	0.015	130	260	0.002	0.002	NA	0.001	0.750	1.64	0.20			
			16	LINEAR	STANDARD Ø0.63	24	SN01	1	0.010	0.007	70	NA	0.006	0.007	NA	0.002	2.938	2.42	0.21
						24	SN02	2	0.006	0.007	70	NA	0.003	0.003	NA	0.001	1.500	2.42	0.21
						24	SN05	5	0.006	0.007	70	NA	0.002	0.002	NA	0.001	0.563	2.42	0.21
24	BZ10	10				0.006	0.008	70	NA	0.002	0.002	NA	0.001	0.438	2.42	0.21			
24	BN(L)08	8				0.003	0.015	130	260	0.002	0.002	NA	0.001	0.500	2.50	0.21			
COMPOSITE	STANDARD Ø0.63	24		SN01	1	0.010	0.007	70	NA	0.006	0.007	NA	0.002	6.125	2.42	0.21			
		24		SN02	2	0.006	0.007	70	NA	0.003	0.003	NA	0.001	3.063	2.42	0.21			
		24		SN05	5	0.006	0.007	70	NA	0.002	0.002	NA	0.001	1.250	2.42	0.21			
		24		BZ10	10	0.006	0.008	70	NA	0.002	0.002	NA	0.001	0.938	2.42	0.21			
		24		BN(L)08	8	0.003	0.015	130	260	0.002	0.002	NA	0.001	0.688	2.50	0.21			
	OVERSIZED Ø0.75	24		SN01	1	0.010	0.007	70	NA	0.006	0.007	NA	0.002	6.625	2.94	0.29			
		24		SN02	2	0.006	0.007	70	NA	0.003	0.003	NA	0.001	3.313	2.94	0.29			
		24		SN05	5	0.006	0.007	70	NA	0.002	0.002	NA	0.001	1.313	2.94	0.29			
		24		BZ10	10	0.006	0.008	70	NA	0.002	0.002	NA	0.001	1.000	2.94	0.29			
		24		BN(L)08	8	0.003	0.015	130	260	0.002	0.002	NA	0.001	0.750	3.02	0.29			

SCREW CODE	DESCRIPTION
BN	Ball Nut
BNH	Ball Nut H-series
BNL	Low-Backlash Ball Nut
BNM	Ball Nut Metric

SCREW CODE	DESCRIPTION
BZ	Bronze Nut
RN	Roller Nut
SN	Solid Nut



Contact Tolomatic for higher accuracy and lower backlash options.
† (L) for low backlash ball screws: backlash = 0.0020" (0.05 mm)

* For SN & BZ screws, maximum continuous dynamic thrust subject to Thrust x Velocity limitation.

** For RN, BN & BNL screws, dynamic load rating reflects 90% reliability for 1 million revolutions.

GSA

GSA Guided Electric Rod-Style Actuator



sizeit.tolomatic.com
for fast, accurate
actuator selection

SIZE: **ALL**

units: **US standard**

SPECIFICATIONS

GSA SIZE	BEARING TYPE	GUIDE ROD in	MAX. STROKE in	SCREW TYPE	TPI turns/in	LEAD ACCURACY† in/ft	BACKLASH in	MAX THRUST* lbf	DYNAMIC LOAD RATING** lbf	BASE ACTUATOR INERTIA			INERTIA PER/in OF STROKE lb-in ²	DYNAMIC FRIC- TION TORQUE lb-in	MOVING PARTS WEIGHT			
										In Line lb-in ²	Reverse Parallel				Base lb	Per Inch lb		
											1:1 lb-in ²	2:1 lb-in ²						
24	LINEAR	STANDARD Ø0.75	30	BZ10	10	0.006	0.008	603	NA	0.116	0.117	0.071	0.004	2.000	4.49	0.33		
			30	BN(L)05	5	0.003	0.015	825	1,411	0.116	0.117	0.071	0.004	1.563	4.75	0.33		
			30	BN(L)02	2	0.003	0.015	342	1,071	0.116	0.117	0.071	0.003	1.56	4.75	0.33		
		COMPOSITE	STANDARD Ø0.75	30	BZ10	10	0.006	0.008	603	NA	0.116	0.117	0.071	0.004	2.000	4.49	0.33	
				30	BN(L)05	5	0.003	0.015	825	1,411	0.116	0.117	0.071	0.004	1.563	4.75	0.33	
				30	BN(L)02	2	0.003	0.015	342	1,071	0.116	0.117	0.071	0.003	1.56	4.75	0.33	
	OVERSIZED Ø1.00	STANDARD Ø1.00	30	BZ10	10	0.006	0.008	603	NA	0.116	0.117	0.071	0.004	2.188	6.06	0.53		
			30	BN(L)05	5	0.003	0.015	825	1,411	0.116	0.117	0.071	0.004	1.875	6.32	0.53		
			30	BN(L)02	2	0.003	0.015	342	1,071	0.116	0.117	0.071	0.003	1.88	6.32	0.53		
	32	LINEAR	STANDARD Ø1.00	36	BZ10	10	0.006	0.008	785	NA	0.235	0.179	0.147	0.009	2.000	9.03	0.60	
				36	BN(L)02	2	0.004	0.015	534	3,364	0.235	0.179	0.147	0.010	3.125	9.51	0.60	
				36	BN(L)05	5	0.003	0.015	950	1,624	0.235	0.179	0.147	0.009	1.875	9.51	0.60	
36				BNM20	1.27	0.002	0.005	339	2,560	0.235	0.179	0.147	0.011	1.875	9.51	0.60		
COMPOSITE		STANDARD Ø1.00	STANDARD Ø1.00	36	BZ10	10	0.006	0.008	785	NA	0.235	0.179	0.147	0.009	2.813	9.03	0.60	
				36	BN(L)02	2	0.004	0.015	534	3,364	0.235	0.179	0.147	0.010	3.438	9.51	0.60	
				36	BN(L)05	5	0.003	0.015	950	1,624	0.235	0.179	0.147	0.009	2.188	9.51	0.60	
				36	BNM20	1.27	0.002	0.005	339	2,560	0.235	0.179	0.147	0.011	2.188	9.51	0.60	
		OVERSIZED Ø1.25	STANDARD Ø1.00	OVERSIZED Ø1.25	36	BZ10	10	0.006	0.008	785	NA	0.235	0.179	0.147	0.009	3.438	11.40	0.86
					36	BN(L)02	2	0.004	0.015	534	3,364	0.235	0.179	0.147	0.010	4.063	11.88	0.86
					36	BN(L)05	5	0.003	0.015	950	1,624	0.235	0.179	0.147	0.009	2.500	11.88	0.86
					36	BNM20	1.27	0.002	0.005	339	2,560	0.235	0.179	0.147	0.011	2.500	11.88	0.86

SCREW CODE	DESCRIPTION
BN	Ball Nut
BNH	Ball Nut H-series
BNL	Low-Backlash Ball Nut
BNM	Ball Nut Metric

SCREW CODE	DESCRIPTION
BZ	Bronze Nut
RN	Roller Nut
SN	Solid Nut



Contact Tolomatic for higher accuracy and lower backlash options.
† (L) for low backlash ball screws: backlash = 0.0020" (0.05 mm)

* For SN & BZ screws, maximum continuous dynamic thrust subject to Thrust x Velocity limitation.

** For RN, BN & BNL screws, dynamic load rating reflects 90% reliability for 1 million revolutions.

GSA Guided Electric Rod-Style Actuator



sizeit.tolomatic.com
for fast, accurate
actuator selection

SIZE: ALL

units: metric**

SPECIFICATIONS

** GSA metric actuators use the same leadscrew as the GSA inch actuators. Threaded mounting and dowel pin holes are metric.

GSA SIZE	BEARING TYPE	GUIDE ROD	MAX. STROKE	SCREW TYPE	LEAD	LEAD ACCURACY	BACKLASH†	MAX THRUST*	DYNAMIC THRUST RATING**	BASE ACTUATOR INERTIA			INERTIA PER/ 25mm OF STROKE	DYNAMIC FRICTION TORQUE	MOVING PARTS WEIGHT	
										In Line	Reverse Parallel				Base	Per Inch
											1:1	2:1				
		mm	mm		mm/rev	mm/300	mm	N		kg-m ² x10 ⁻⁶	kg-m ² x10 ⁻⁶	kg-m ² x10 ⁻⁶	kg-m ² x10 ⁻⁶	N-m	Kg	Kg
12	LINEAR	STANDARD Ø12.7	457.2	SN01	25.40	0.25	0.18	311	NA	1.171	1.463	NA	0.585	0.332	0.549	0.063
			457.2	SN02	12.70	0.15	0.18	311	NA	0.585	0.878	NA	0.293	0.169	0.549	0.063
			457.2	SN05	5.08	0.15	0.18	311	NA	0.585	0.585	NA	0.293	0.064	0.549	0.063
			457.2	BZ10	2.54	0.15	0.20	311	NA	0.585	0.585	NA	0.293	0.049	0.549	0.063
			457.2	BN(L)08	3.18	0.08	0.38	578	1,157	0.585	0.585	NA	0.293	0.056	0.585	0.063
	COMPOSITE	STANDARD Ø12.7	457.2	SN01	25.40	0.25	0.18	311	NA	1.171	1.463	NA	0.585	0.636	0.549	0.063
			457.2	SN02	12.70	0.15	0.18	311	NA	0.585	0.878	NA	0.293	0.318	0.549	0.063
			457.2	SN05	5.08	0.15	0.18	311	NA	0.585	0.585	NA	0.293	0.127	0.549	0.063
			457.2	BZ10	2.54	0.15	0.20	311	NA	0.585	0.585	NA	0.293	0.092	0.549	0.063
			457.2	BN(L)08	3.18	0.08	0.38	578	1,157	0.585	0.585	NA	0.293	0.078	0.585	0.063
		OVERSIZED Ø15.9	457.2	SN01	25.40	0.25	0.18	311	NA	1.171	1.463	NA	0.585	0.692	0.707	0.09
			457.2	SN02	12.70	0.15	0.18	311	NA	0.585	0.878	NA	0.293	0.346	0.707	0.09
			457.2	SN05	5.08	0.15	0.18	311	NA	0.585	0.585	NA	0.293	0.141	0.707	0.09
			457.2	BZ10	2.54	0.15	0.20	311	NA	0.585	0.585	NA	0.293	0.106	0.707	0.09
			457.2	BN(L)08	3.18	0.08	0.38	578	1,157	0.585	0.585	NA	0.293	0.085	0.744	0.09
			457.2	BN(L)08	3.18	0.08	0.38	578	1,157	0.585	0.585	NA	0.293	0.085	0.744	0.09
16	LINEAR	STANDARD Ø15.9	609.6	SN01	25.40	0.25	0.18	311	NA	1.756	2.048	NA	0.585	0.332	1.10	0.095
			609.6	SN02	12.70	0.15	0.18	311	NA	0.878	0.878	NA	0.293	0.169	1.10	0.095
			609.6	SN05	5.08	0.15	0.18	311	NA	0.585	0.585	NA	0.293	0.064	1.10	0.095
			609.6	BZ10	2.54	0.15	0.20	311	NA	0.585	0.585	NA	0.293	0.049	1.10	0.095
			609.6	BN(L)08	3.18	0.08	0.38	578	1,157	0.585	0.585	NA	0.293	0.056	1.13	0.095
	COMPOSITE	STANDARD Ø15.9	609.6	SN01	25.40	0.25	0.18	311	NA	1.756	2.048	NA	0.585	0.692	1.10	0.095
			609.6	SN02	12.70	0.15	0.18	311	NA	0.878	0.878	NA	0.293	0.346	1.10	0.095
			609.6	SN05	5.08	0.15	0.18	311	NA	0.585	0.585	NA	0.293	0.141	1.10	0.095
			609.6	BZ10	2.54	0.15	0.20	311	NA	0.585	0.585	NA	0.293	0.106	1.10	0.095
			609.6	BN(L)08	3.18	0.08	0.38	578	1,157	0.585	0.585	NA	0.293	0.078	1.13	0.095
		OVERSIZED Ø19.1	609.6	SN01	25.40	0.25	0.18	311	NA	1.756	2.048	NA	0.585	0.749	1.33	0.132
			609.6	SN02	12.70	0.15	0.18	311	NA	0.878	0.878	NA	0.293	0.374	1.33	0.132
			609.6	SN05	5.08	0.15	0.18	311	NA	0.585	0.585	NA	0.293	0.148	1.33	0.132
			609.6	BZ10	2.54	0.15	0.20	311	NA	0.585	0.585	NA	0.293	0.113	1.33	0.132
			609.6	BN(L)08	3.18	0.08	0.38	578	1,157	0.585	0.585	NA	0.293	0.085	1.37	0.132
			609.6	BN(L)08	3.18	0.08	0.38	578	1,157	0.585	0.585	NA	0.293	0.085	1.37	0.132

SCREW CODE	DESCRIPTION
BN	Ball Nut
BNH	Ball Nut H-series
BNL	Low-Backlash Ball Nut
BNM	Ball Nut Metric

SCREW CODE	DESCRIPTION
BZ	Bronze Nut
RN	Roller Nut
SN	Solid Nut



Contact Tolomatic for higher accuracy and lower backlash options.
† (L) for low backlash ball screws: backlash = 0.0020" (0.05 mm)

* For SN & BZ screws, maximum continuous dynamic thrust subject to Thrust x Velocity limitation.

** For RN, BN & BNL screws, dynamic load rating reflects 90% reliability for 1 million revolutions.

GSA Guided Electric Rod-Style Actuator



sizeit.tolomatic.com
for fast, accurate
actuator selection

SIZE: **ALL**

units: **metric****

SPECIFICATIONS

** GSA metric actuators use the same leadscrew as the GSA inch actuators. Threaded mounting and dowel pin holes are metric.

GSA SIZE	BEARING TYPE	GUIDE ROD	MAX. STROKE	SCREW TYPE	LEAD	LEAD ACCURACY	BACKLASH†	MAX THRUST*	DYNAMIC THRUST RATING**	BASE ACTUATOR INERTIA			INERTIA PER/ 25mm OF STROKE	DYNAMIC FRICTION TORQUE	MOVING PARTS WEIGHT		
										In Line	Reverse Parallel				Base	Per Inch	
											1:1	2:1					
											kg-m ² x10 ⁻⁶	kg-m ² x10 ⁻⁶					kg-m ² x10 ⁻⁶
24	LINEAR	STANDARD Ø19.1	762.0	BZ10	2.54	0.15	0.20	2,682	NA	33.946	34.239	20.777	1.171	0.226	2.04	0.15	
			762.0	BN(L)05	5.08	0.08	0.38	3,670	6,275	33.946	34.239	20.777	1.171	0.177	2.15	0.15	
			762.0	BN(L)02	12.70	0.08	0.38	1,521	4,764	33.946	34.239	20.777	0.878	0.176	2.15	0.15	
		COMPOSITE	STANDARD Ø19.1	762.0	BZ10	2.54	0.15	0.20	2,682	NA	33.946	34.239	20.777	1.171	0.226	2.04	0.15
				762.0	BN(L)05	5.08	0.08	0.38	3,670	6,275	33.946	34.239	20.777	1.171	0.177	2.15	0.15
				762.0	BN(L)02	12.70	0.08	0.38	1,521	4,764	33.946	34.239	20.777	0.878	0.176	2.15	0.15
	OVERSIZED Ø25.4		762.0	BZ10	2.54	0.15	0.20	2,682	NA	33.946	34.239	20.777	1.171	0.247	2.75	0.24	
			762.0	BN(L)05	5.08	0.08	0.38	3,670	6,275	33.946	34.239	20.777	1.171	0.212	2.87	0.24	
			762.0	BN(L)02	12.70	0.08	0.38	1,521	4,764	33.946	34.239	20.777	0.878	0.212	2.87	0.24	
	32	LINEAR	STANDARD Ø25.4	914.4	BZ10	2.54	0.15	0.20	3,492	NA	68.770	52.382	43.018	2.634	0.226	4.10	0.27
				914.4	BN(L)02	12.70	0.10	0.38	2,375	14,964	68.770	52.382	43.018	2.926	0.353	4.31	0.27
				914.4	BN(L)05	5.08	0.08	0.38	4,226	7,226	68.770	52.382	43.018	2.634	0.212	4.31	0.27
914.4				BNM20	20.00	0.05	0.13	1,508	11,388	68.770	52.382	43.018	3.219	0.212	4.31	0.27	
COMPOSITE			STANDARD Ø25.4	914.4	BZ10	2.54	0.15	0.20	3,492	NA	68.770	52.382	43.018	2.634	0.318	4.10	0.27
				914.4	BN(L)02	12.70	0.10	0.38	2,375	14,964	68.770	52.382	43.018	2.926	0.388	4.31	0.27
		914.4		BN(L)05	5.08	0.08	0.38	4,226	7,226	68.770	52.382	43.018	2.634	0.247	4.31	0.27	
		914.4		BNM20	20.00	0.05	0.13	1,508	11,388	68.770	52.382	43.018	3.219	0.212	4.31	0.27	
OVERSIZED Ø31.8		914.4	BZ10	2.54	0.15	0.20	3,492	NA	68.770	52.382	43.018	2.634	0.388	5.17	0.39		
		914.4	BN(L)02	12.70	0.10	0.38	2,375	14,964	68.770	52.382	43.018	2.926	0.459	5.39	0.39		
		914.4	BN(L)05	5.08	0.08	0.38	4,226	7,226	68.770	52.382	43.018	2.634	0.282	5.39	0.39		
		914.4	BNM20	20.00	0.05	0.13	1,508	11,388	68.770	52.382	43.018	3.219	0.282	5.39	0.39		

SCREW CODE	DESCRIPTION
BN	Ball Nut
BNH	Ball Nut H-series
BNL	Low-Backlash Ball Nut
BNM	Ball Nut Metric

SCREW CODE	DESCRIPTION
BZ	Bronze Nut
RN	Roller Nut
SN	Solid Nut



Contact Tolomatic for higher accuracy and lower backlash options.

† (L) for low backlash ball screws: backlash = 0.0020" (0.05 mm)

* For SN & BZ screws, maximum continuous dynamic thrust subject to Thrust x Velocity limitation.

** For RN, BN & BNL screws, dynamic load rating reflects 90% reliability for 1 million revolutions.

GSA Guided Electric Rod-Style Actuator

sizeit.tolomatic.com
for fast, accurate
actuator selection

SIZE: 12,16: CRITICAL SPEED CAPACITIES

SPECIFICATIONS

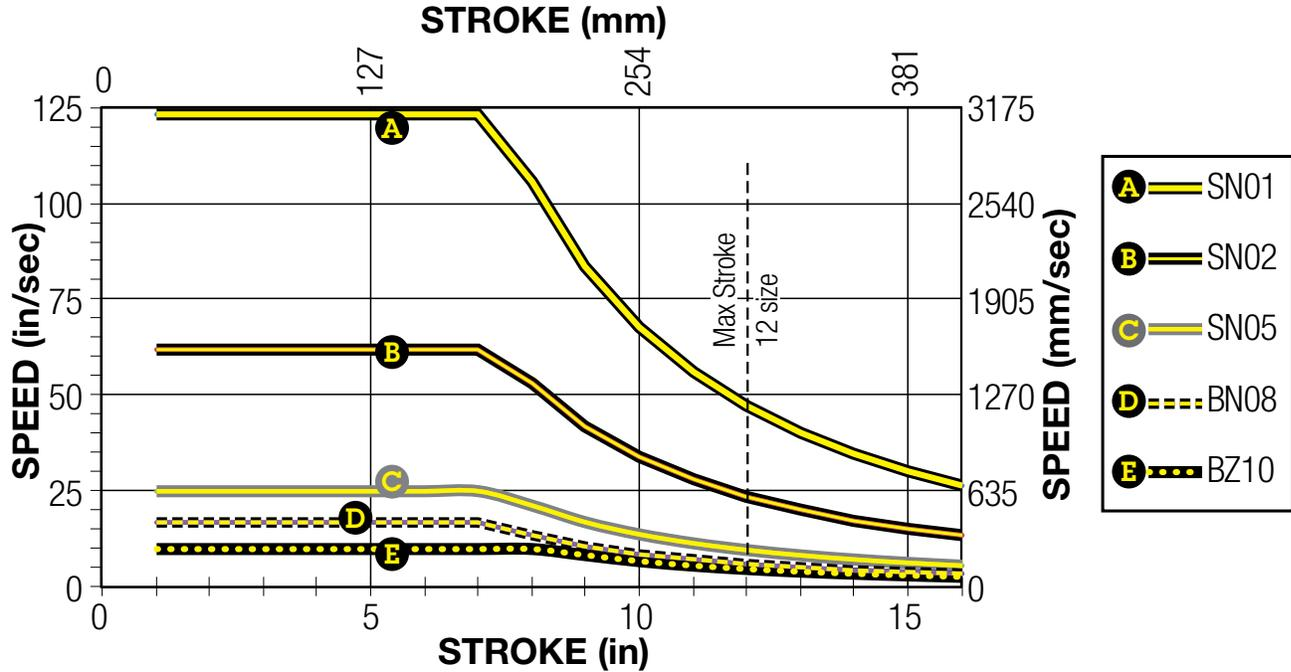

SIZE: 24: CRITICAL SPEED CAPACITIES

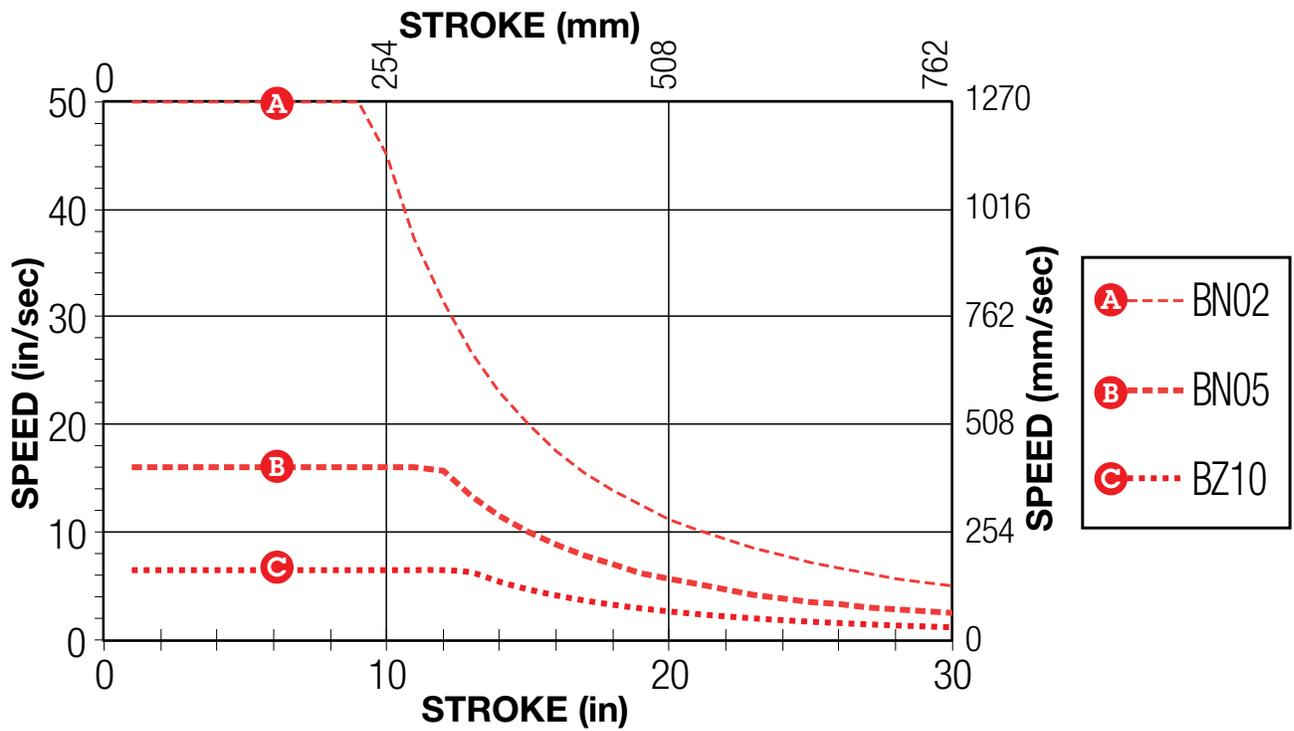

SCREW CODE	DESCRIPTION	SCREW CODE	DESCRIPTION
BN	Ball Nut	BZ	Bronze Nut
BNH	Ball Nut H-series	RN	Roller Nut
BNL	Low-Backlash Ball Nut	SN	Solid Nut
BNM	Ball Nut Metric		

GSA

GSA Guided Electric Rod-Style Actuator

sizeit.tolomatic.com
for fast, accurate
actuator selection

SIZE: 32: CRITICAL SPEED CAPACITIES

SPECIFICATIONS

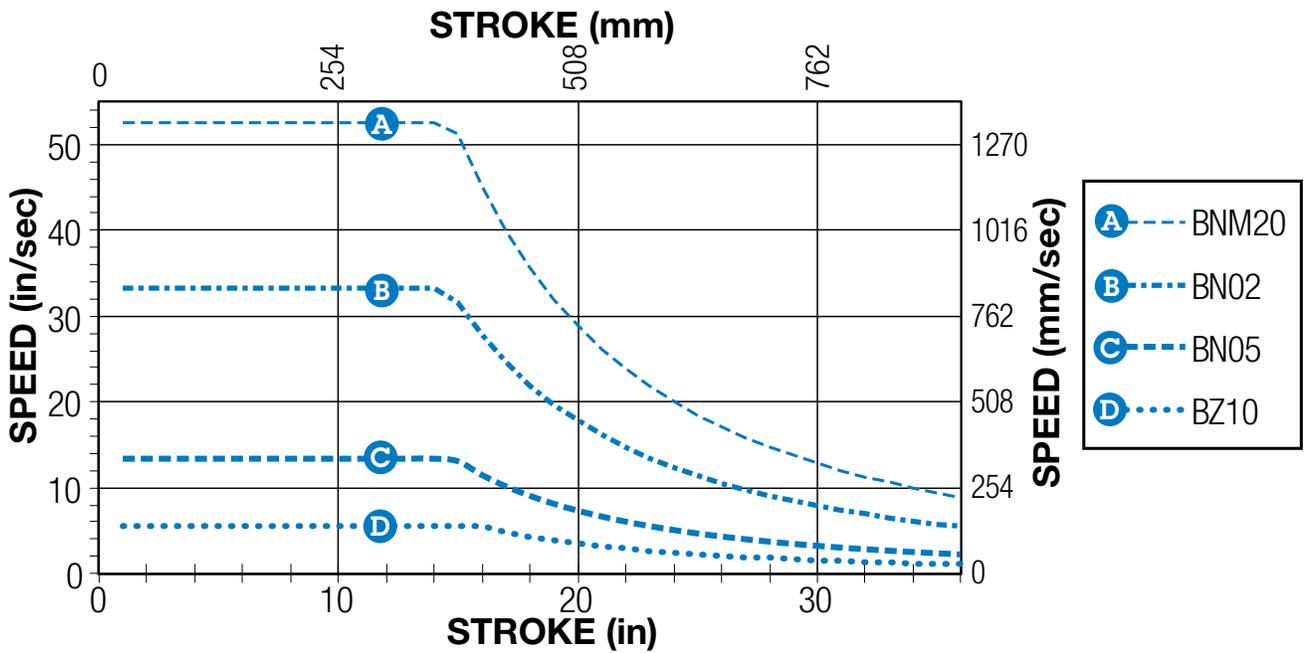

SIZE: 12,16: PV LIMITS (Solid Nuts)

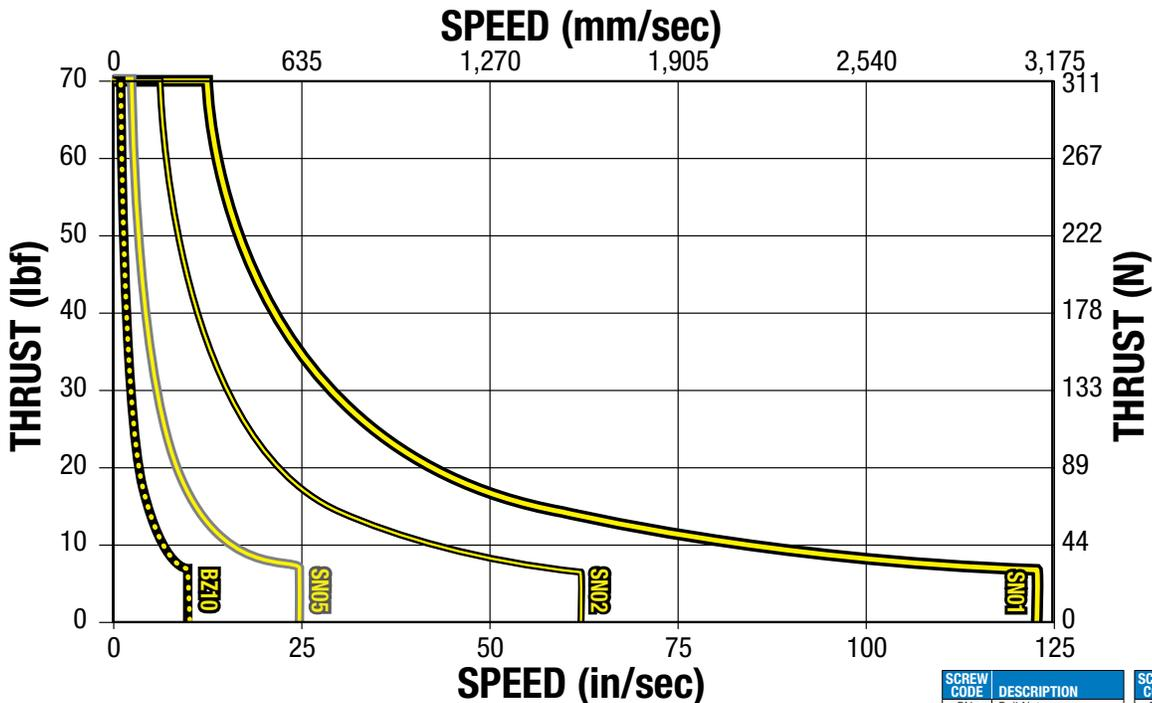

PV LIMITS

PV LIMITS: Any material which carries a sliding load is limited by heat buildup. The factors that affect heat generation rate in an application are the pressure on the nut in pounds per square inch and the surface velocity in feet per minute. The product of these factors provides a measure of the severity of an application.

$$P \times V \leq 0.1$$

$$\left(\frac{\text{Thrust}}{\text{Max. Thrust Rating}} \right) \times \left(\frac{\text{Speed}}{\text{Max. Speed Rating}} \right) \leq 0.1$$

SCREW CODE	DESCRIPTION	SCREW CODE	DESCRIPTION
BN	Ball Nut	BZ	Bronze Nut
BNH	Ball Nut H-series	RN	Roller Nut
BNL	Low-Backlash Ball Nut	SN	Solid Nut
BNM	Ball Nut Metric		

GSA Guided Electric Rod-Style Actuator

SIZE: 24,32 (BZ): PV LIMITS (Bronze Nuts)

SPECIFICATIONS

sizeit.tolomatic.com
for fast, accurate
actuator selection

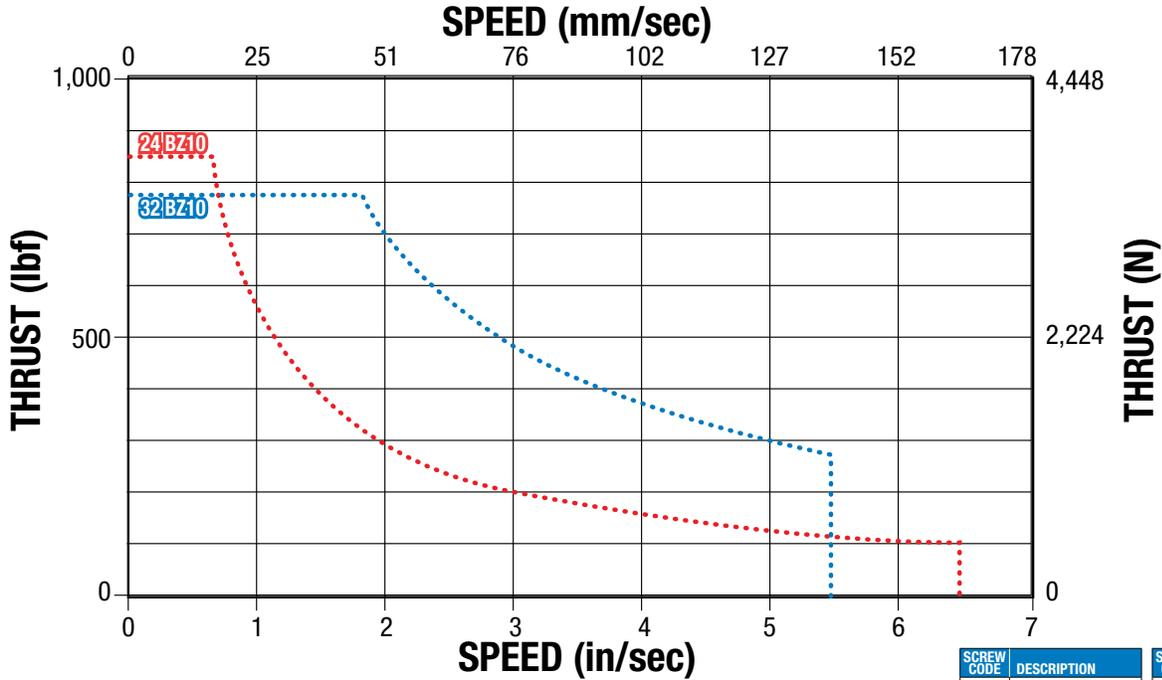

PV LIMITS

PV LIMITS: Any material which carries a sliding load is limited by heat buildup. The factors that affect heat generation rate in an application are the pressure on the nut in pounds per square inch and the surface velocity in feet per minute. The product of these factors provides a measure of the severity of an application.

$$\left(\frac{\text{Thrust}}{\text{(Max. Thrust Rating)}} \right) \times \left(\frac{\text{Speed}}{\text{(Max. Speed Rating)}} \right) \leq 0.1$$

SCREW BUCKLING LOAD

SIZE: 12, 16, 24, 32

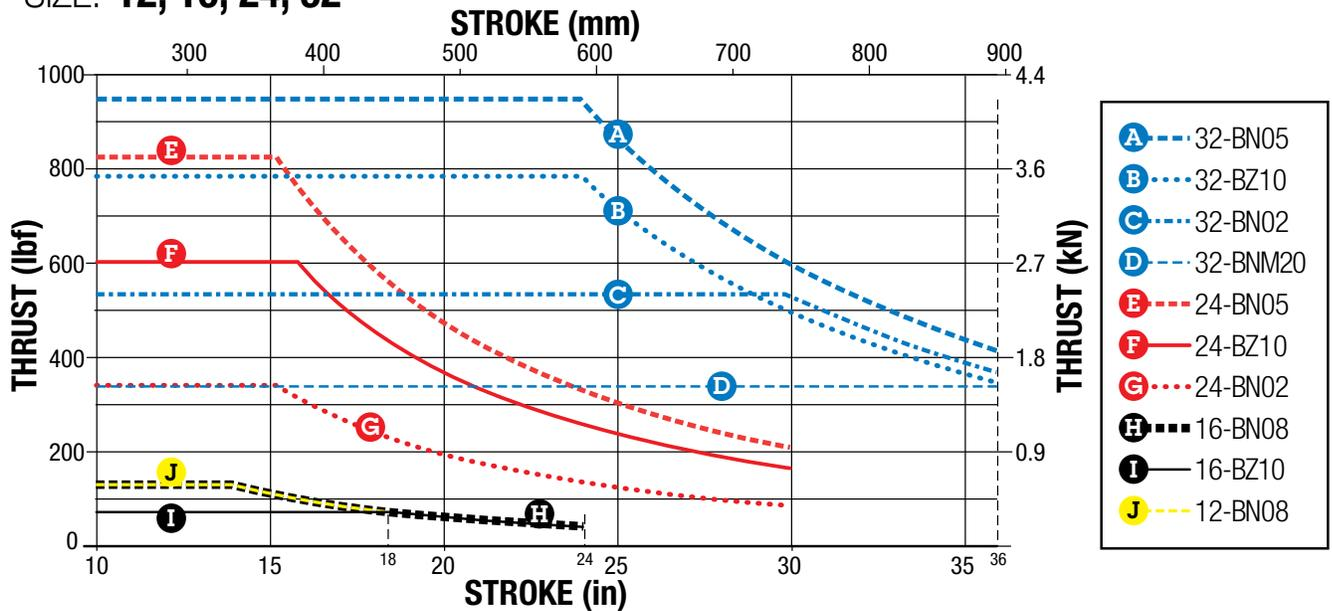

NOTE: Buckling load limits shown assume perfect alignment. It is recommended to use additional safety margin, particularly in high thrust applications

SCREW CODE	DESCRIPTION	SCREW CODE	DESCRIPTION
BN	Ball Nut	BZ	Bronze Nut
BNH	Ball Nut H-series	RN	Roller Nut
BNL	Low-Backlash Ball Nut	SN	Solid Nut
BNM	Ball Nut Metric		

GSA Guided Electric Rod-Style Actuator

BALL SCREW LIFE GRAPHS

SPECIFICATIONS



SIZE: 12, 16, 24, 32

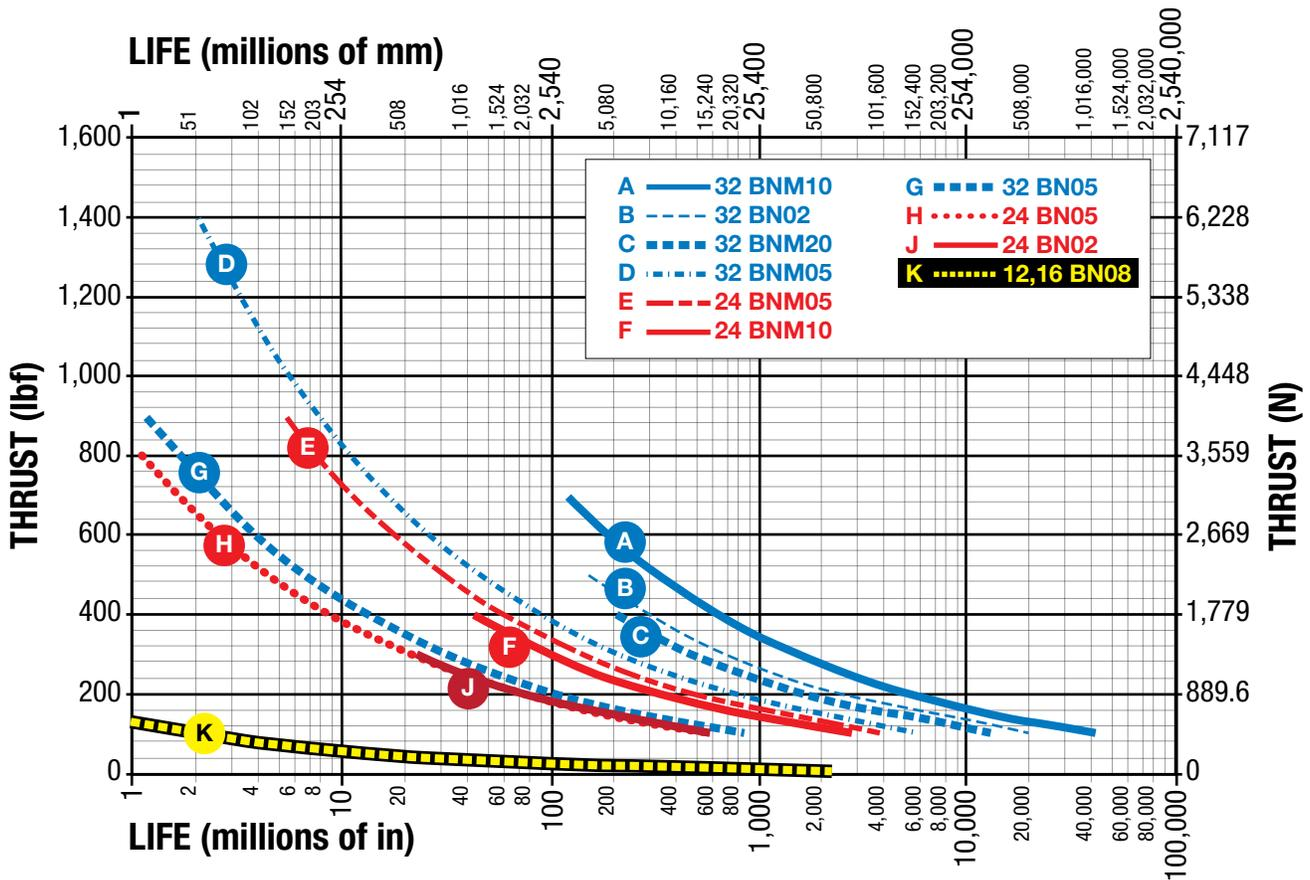

NOTE: The L_{10} expected life of a ball screw linear actuator is expressed as the linear travel distance that 90% of properly maintained ball screw manufactured are expected to meet or exceed. This is not a guarantee and this graph should be used for estimation purposes only.

The underlying formula that defines this value is:

$$L_{10} = \left(\frac{C}{P_e} \right)^3 \cdot \ell \equiv$$

L_{10} Travel life in millions of units (in or mm), where:

- C = Dynamic load rating (lbf) or (N)
- P_e = Equivalent load (lbf) or (N)
If load is constant across all movements then:
actual load = equivalent load
- ℓ = Screw lead (in/rev) (mm/rev)

Use the "Equivalent Load" calculation below, when the load is not constant throughout the entire stroke. In cases where there is only minor variation in loading, use greatest load for life calculations.

Where:
$$P_e = \sqrt[3]{\frac{L_1(P_1)^3 + L_2(P_2)^3 + L_3(P_3)^3 + L_n(P_n)^3}{L}}$$

- P_e = Equivalent load (lbf) or (N)
- P_n = Each increment at different load (lbf) or (N)
- L = Total distanced traveled per cycle (extend + retract stroke)
[$L = L_1 + L_2 + L_3 + L_n$]
- L_n = Each increment of stroke at different load (in) or (mm)

GSA Guided Electric Rod-Style Actuator

SIZE: ALL

SPECIFICATIONS



sizeit.tolomatic.com
for fast, accurate
actuator selection

GSA SIZE				12				16		24		32	
				17 frame		23 frame							
Guide Rod				STD	OVR	STD	OVR	STD	OVR	STD	OVR		
WEIGHT	BASE MODEL	IN-LINE	lb	3.65	4.44	3.68	4.47	7.25	7.54	16.48	17.35	27.34	28.65
		REVERSE PARALLEL	lb	3.92	4.72	4.05	4.85	7.59	7.88	17.09	17.96	28.81	30.12
		PER in OF STROKE	lb/in	0.21	0.27	0.21	0.27	0.30	0.38	0.54	0.74	0.93	1.19
MAX. STROKE			in	18				24		30		36	
TEMP. RANGE*			°F	Standard: 40 to 130 Extended: -40 to 140									



Contact Tolomatic if operation in the extended range is required.

GSA SIZE				12				16		24		32	
				17 frame		23 frame							
Guide Rod				STD	OVR	STD	OVR	STD	OVR	STD	OVR		
WEIGHT	BASE MODEL	IN-LINE	kg	1.65	2.01	1.67	2.03	3.29	3.42	7.48	7.87	12.40	13.00
		REVERSE PARALLEL	kg	1.78	2.14	1.84	2.20	3.44	3.57	7.75	8.15	13.07	13.66
		PER in OF STROKE	g/mm	3.75	4.82	3.75	4.82	5.36	6.79	9.64	13.21	16.61	21.25
MAX. STROKE			mm	457				609		762		914	
TEMP. RANGE*			°C	Standard: 4 - 54 Extended: -40 to 60									

Gasket Kit providing ingress protection against dust and splashing water available upon request



Contact Tolomatic if operation in the extended range is required.



* Heat generated by the motor and drive should be taken into consideration as well as linear velocity and work cycle time. For applications that require operation outside of the recommended temperature range, contact Tolomatic.

LARGE FRAME MOTORS AND SMALLER SIZE ACTUATORS: Cantilevered motors need to be supported, if subjected to continuous rapid reversing duty and/or under dynamic conditions.

SIDE LOADING CONSIDERATIONS: Rod screw actuators are designed to push guided and supported loads and are not meant for applications that require substantial side loading. Please contact Tolomatic for details regarding side loading capabilities.

GSA

GSA Guided Electric Rod-Style Actuator

SIZE: 12

SPECIFICATIONS

sizeit.tolomatic.com
for fast, accurate
actuator selection

MAX. LOAD WEIGHT & GUIDE ROD DEFLECTION

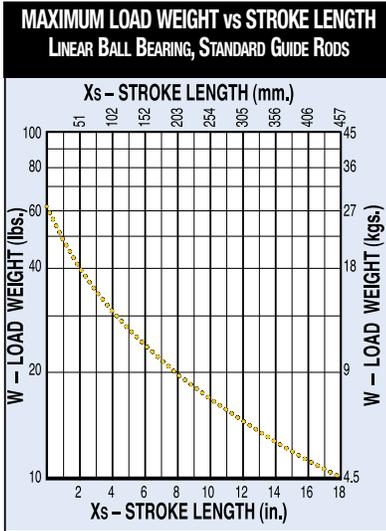

Linear ball bearings are not available with stainless steel guide rod option.

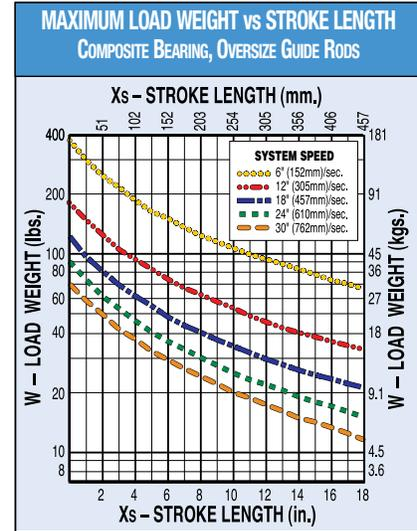
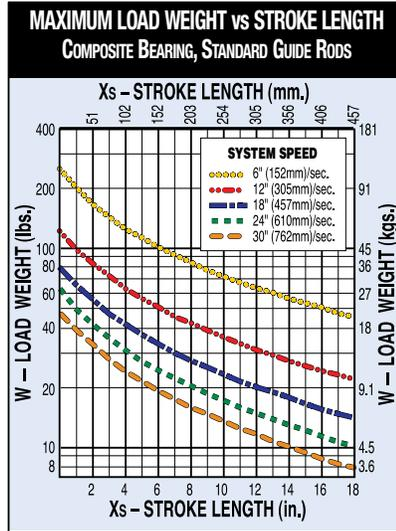

DO NOT EXCEED MAXIMUM LOAD CURVE

Maximum load values are based on 200 million linear inches of travel.

- To obtain most accurate results, stroke length should be adjusted by the distance between the center of mass of the load and tooling plate.

$$X_{adj} = X_s + X_{cm}$$

Then, use X_{adj} instead of X_s on the Maximum Load Weight vs. Stroke Length graph.

- For the off-center loads, calculate adjusted load weight using the following formula:

$$W_{adj} = W (1 + 0.67 Y_{cm})$$

where Y_{cm} is distance between center of mass of off-center load and center of tooling plate.

Then, use W_{adj} instead of W on Maximum Load Weight vs. Stroke Length graph.

- Using your stroke length and load weight, evaluate guide rod deflection. If the intersection point is above the highest curve (.064"), contact Tolomatic for assistance.

- Impact loading is not recommended for GSA actuators.
- Motor brakes may be required on vertically positioned actuators with plastic (solid) or ball nuts in applications with risk of load backdriving. (Actuators with bronze nuts will not backdrive for loads, thrusts within catalog specifications.)

Contact Tolomatic for assistance.

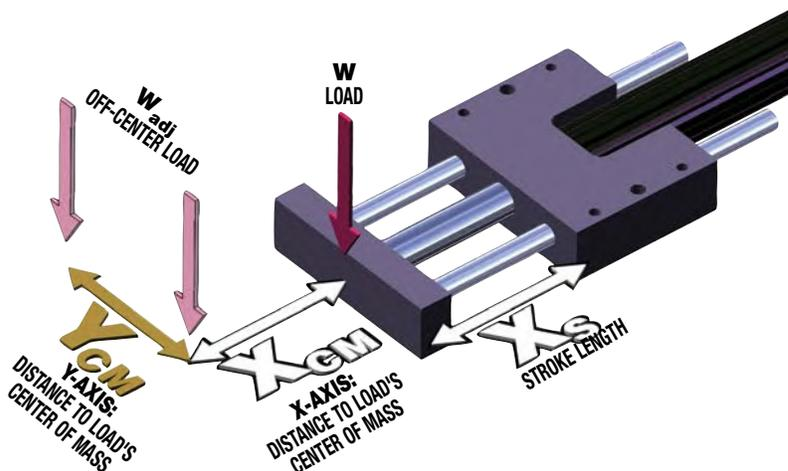
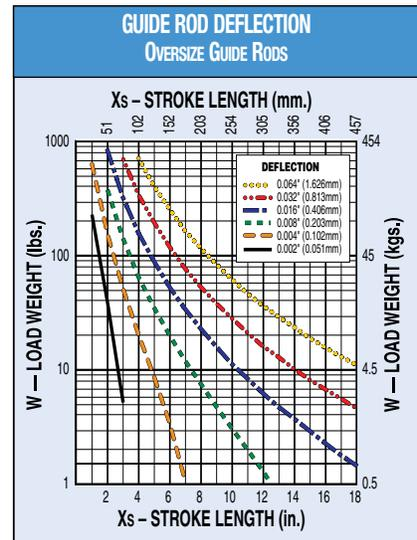
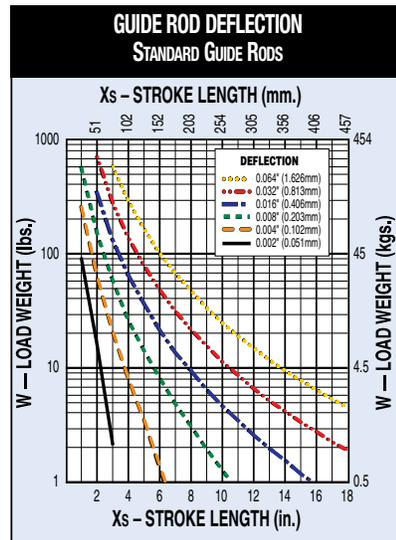

GSA

GSA Guided Electric Rod-Style Actuator

SIZE: 16

SPECIFICATIONS



sizeit.tolomatic.com
for fast, accurate
actuator selection

MAX. LOAD WEIGHT & GUIDE ROD DEFLECTION

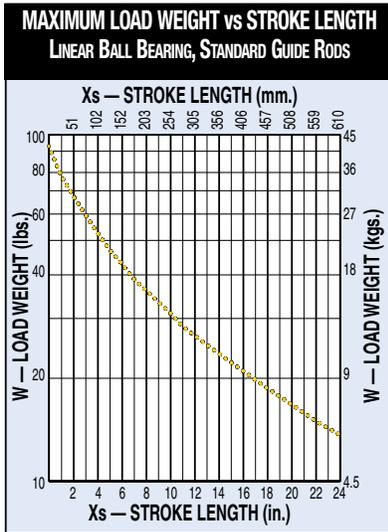

Linear ball bearings are not available with stainless steel guide rod option.

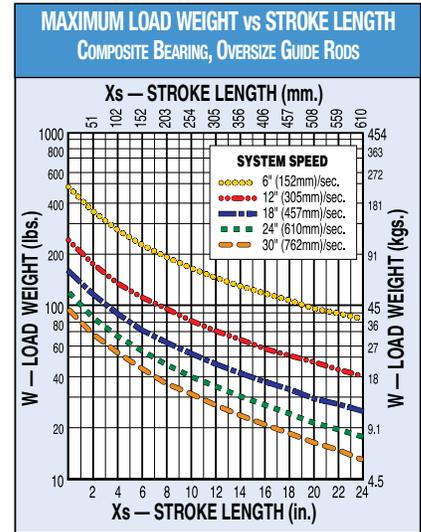
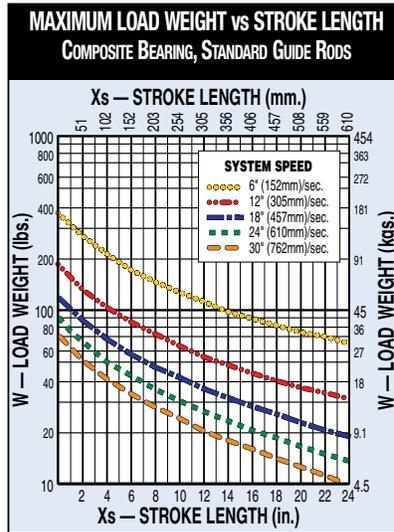

DO NOT EXCEED MAXIMUM LOAD CURVE

Maximum load values are based on 200 million linear inches of travel.

- To obtain most accurate results, stroke length should be adjusted by the distance between the center of mass of the load and tooling plate.

$$X_{adj} = X_s + X_{cm}$$

Then, use X_{adj} instead of X_s on the Maximum Load Weight vs. Stroke Length graph.

- For the off-center loads, calculate adjusted load weight using the following formula:

$$W_{adj} = W (1 + 0.53 Y_{cm})$$

where Y_{cm} is distance between center of mass of off-center load and center of tooling plate.

Then, use W_{adj} instead of W on Maximum Load Weight vs. Stroke Length graph.

- Using your stroke length and load weight, evaluate guide rod deflection. If the intersection point is above the highest curve (.064"), contact Tolomatic for assistance.

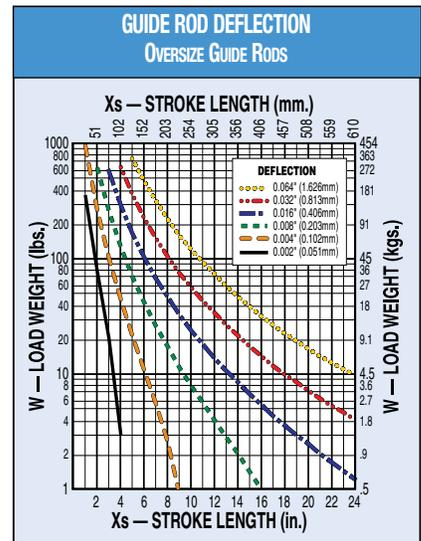
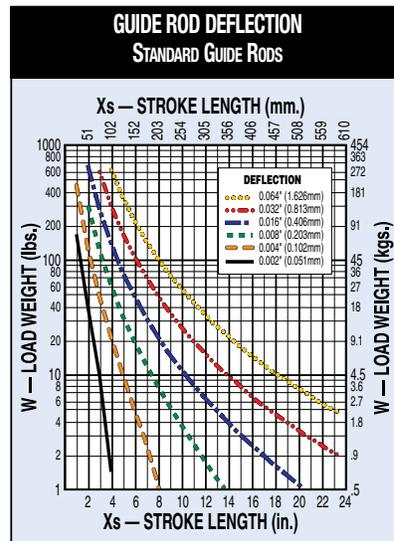

- Impact loading is not recommended for GSA actuators.
- Motor brakes may be required on vertically positioned actuators with plastic (solid) or ball nuts in applications with risk of load backdriving. (Actuators with bronze nuts will not backdrive for loads, thrusts within catalog specifications.)

Contact Tolomatic for assistance.

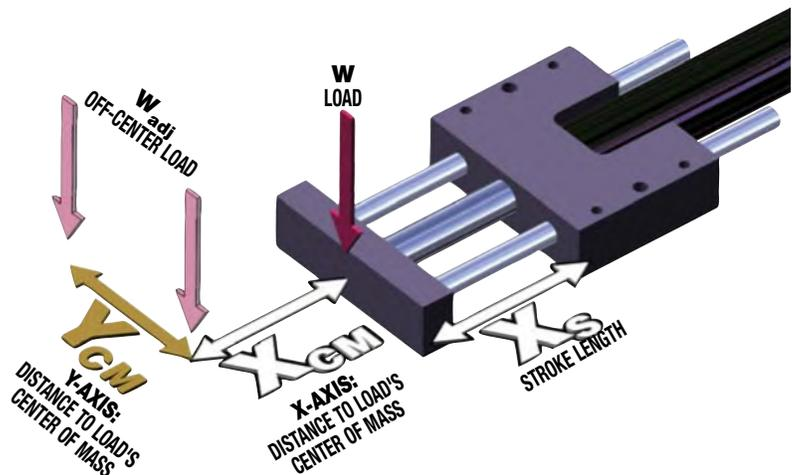

GSA Guided Electric Rod-Style Actuator

SIZE: 24

SPECIFICATIONS

sizeit.tolomatic.com
for fast, accurate
actuator selection

MAX. LOAD WEIGHT & GUIDE ROD DEFLECTION

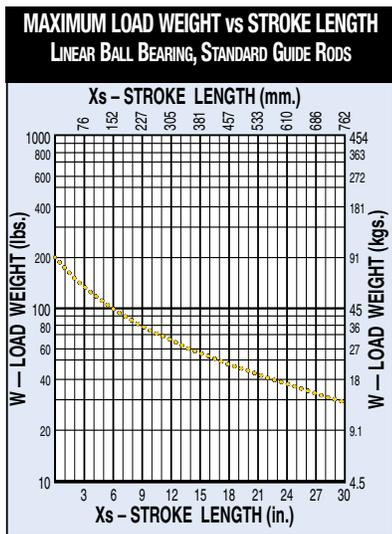

Linear ball bearings are not available with stainless steel guide rod option.

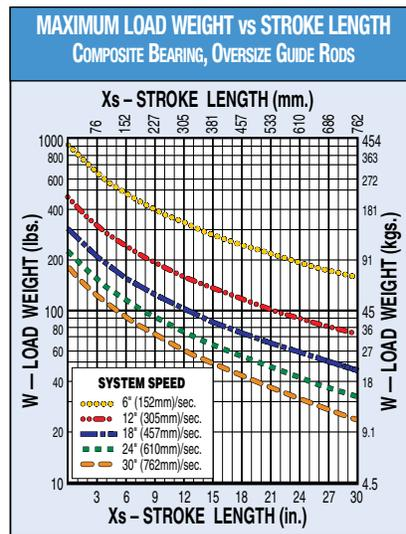
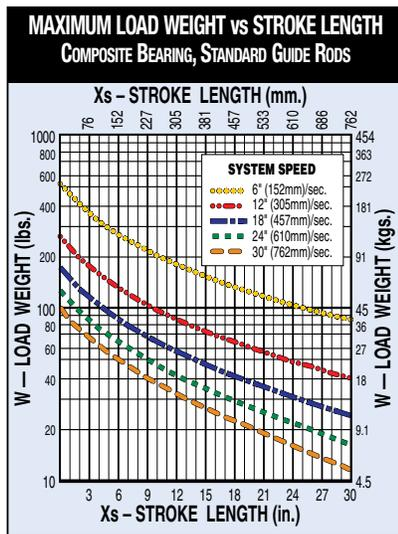

DO NOT EXCEED MAXIMUM LOAD CURVE

Maximum load values are based on 200 million linear inches of travel.

- To obtain most accurate results, stroke length should be adjusted by the distance between the center of mass of the load and tooling plate.

$$X_{adj} = X_s + X_{cm}$$

Then, use X_{adj} instead of X_s on the Maximum Load Weight vs. Stroke Length graph.

- For the off-center loads, calculate adjusted load weight using the following formula:

$$W_{adj} = W (1 + 0.40 Y_{cm})$$

where Y_{cm} is distance between center of mass of off-center load and center of tooling plate.

Then, use W_{adj} instead of W on Maximum Load Weight vs. Stroke Length graph.

- Using your stroke length and load weight, evaluate guide rod deflection. If the intersection point is above the highest curve (.064"), contact Tolomatic for assistance.

- Impact loading is not recommended for GSA actuators.
- Motor brakes may be required on vertically positioned actuators with plastic (solid) or ball nuts in applications with risk of load backdriving. (Actuators with bronze nuts will not backdrive for loads, thrusts within catalog specifications.)

Contact Tolomatic for assistance.

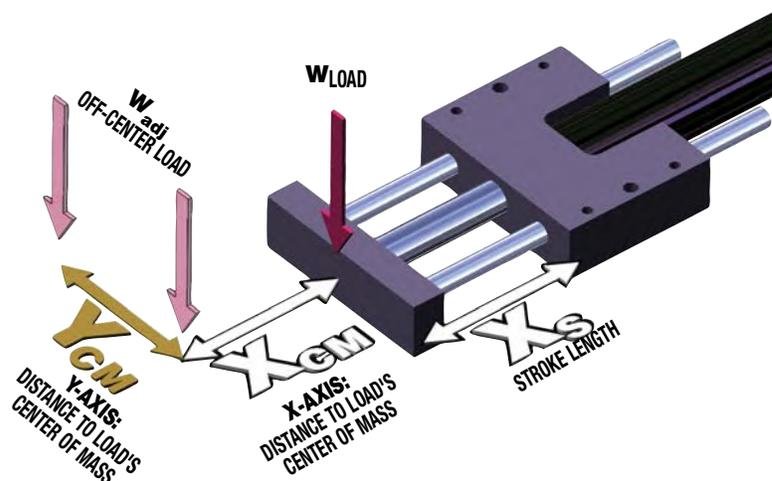
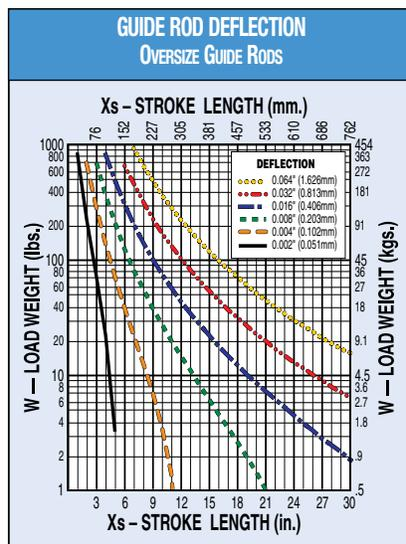
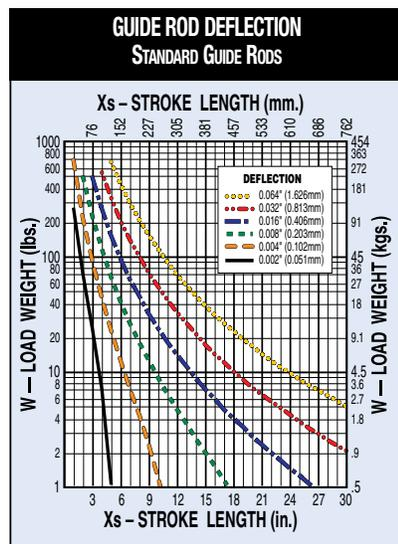

GSA

GSA Guided Electric Rod-Style Actuator

SIZE: 32

SPECIFICATIONS



sizeit.tolomatic.com
for fast, accurate
actuator selection

MAX. LOAD WEIGHT & GUIDE ROD DEFLECTION

MAXIMUM LOAD WEIGHT vs STROKE LENGTH
LINEAR BALL BEARING, STANDARD GUIDE RODS

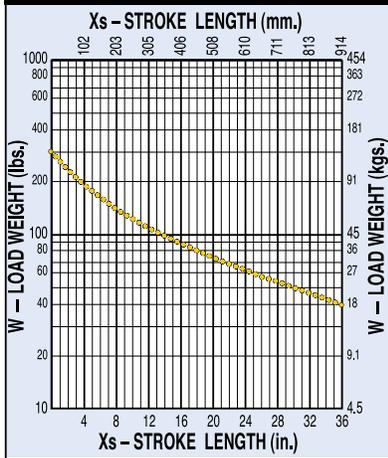

Linear ball bearings are not available with stainless steel guide rod option.

MAXIMUM LOAD WEIGHT vs STROKE LENGTH
COMPOSITE BEARING, STANDARD GUIDE RODS

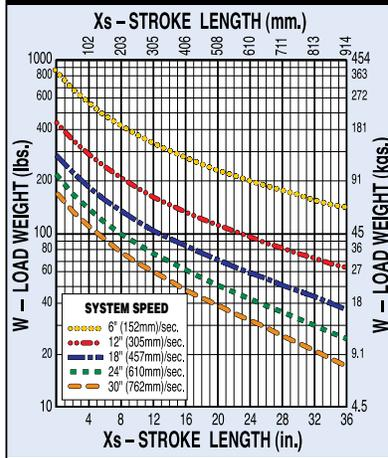

MAXIMUM LOAD WEIGHT vs STROKE LENGTH
COMPOSITE BEARING, OVERSIZE GUIDE RODS

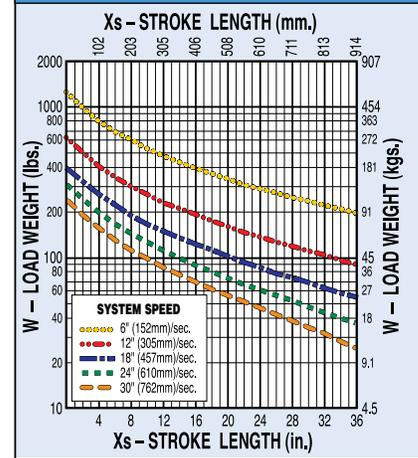

DO NOT EXCEED MAXIMUM LOAD CURVE

Maximum load values are based on 200 million linear inches of travel.

- To obtain most accurate results, stroke length should be adjusted by the distance between the center of mass of the load and tooling plate.

$$X_{adj} = X_s + X_{cm}$$

Then, use X_{adj} instead of X_s on the Maximum Load Weight vs. Stroke Length graph.

- For the off-center loads, calculate adjusted load weight using the following formula:

$$W_{adj} = W (1 + 0.53 Y_{cm})$$

where Y_{cm} is distance between center of mass of off-center load and center of tooling plate.

Then, use W_{adj} instead of W on Maximum Load Weight vs. Stroke Length graph.

- Using your stroke length and load weight, evaluate guide rod deflection. If the intersection point is above the highest curve (.064"), contact Tolomatic for assistance.

GUIDE ROD DEFLECTION
STANDARD GUIDE RODS

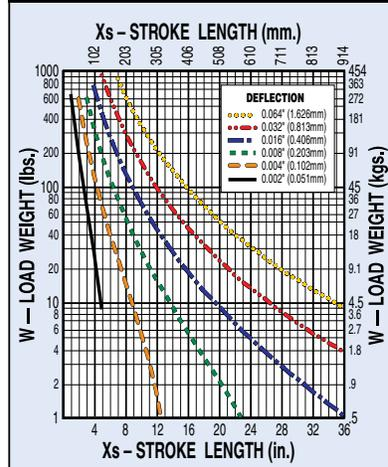

GUIDE ROD DEFLECTION
OVERSIZE GUIDE RODS

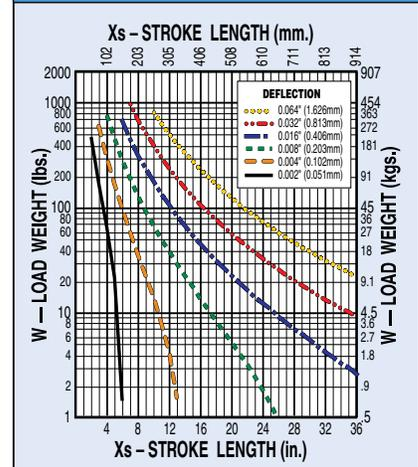

- Impact loading is not recommended for GSA actuators.
- Motor brakes may be required on vertically positioned actuators with plastic (solid) or ball nuts in applications with risk of load backdriving. (Actuators with bronze nuts will not backdrive for loads, thrusts within catalog specifications.)

Contact Tolomatic for assistance.

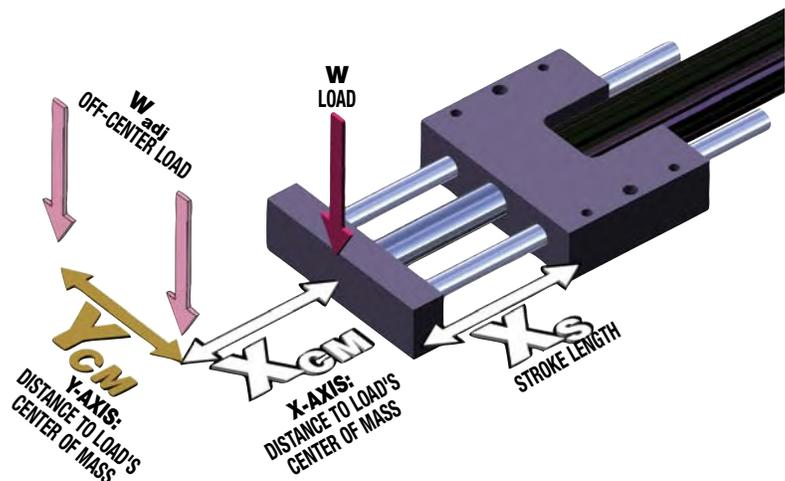

GSA Guided Electric Rod-Style Actuator

SIZE: ALL

DIMENSIONS

tolomatic.com/CAD Download 3D CAD Always use CAD solid model to determine critical dimensions

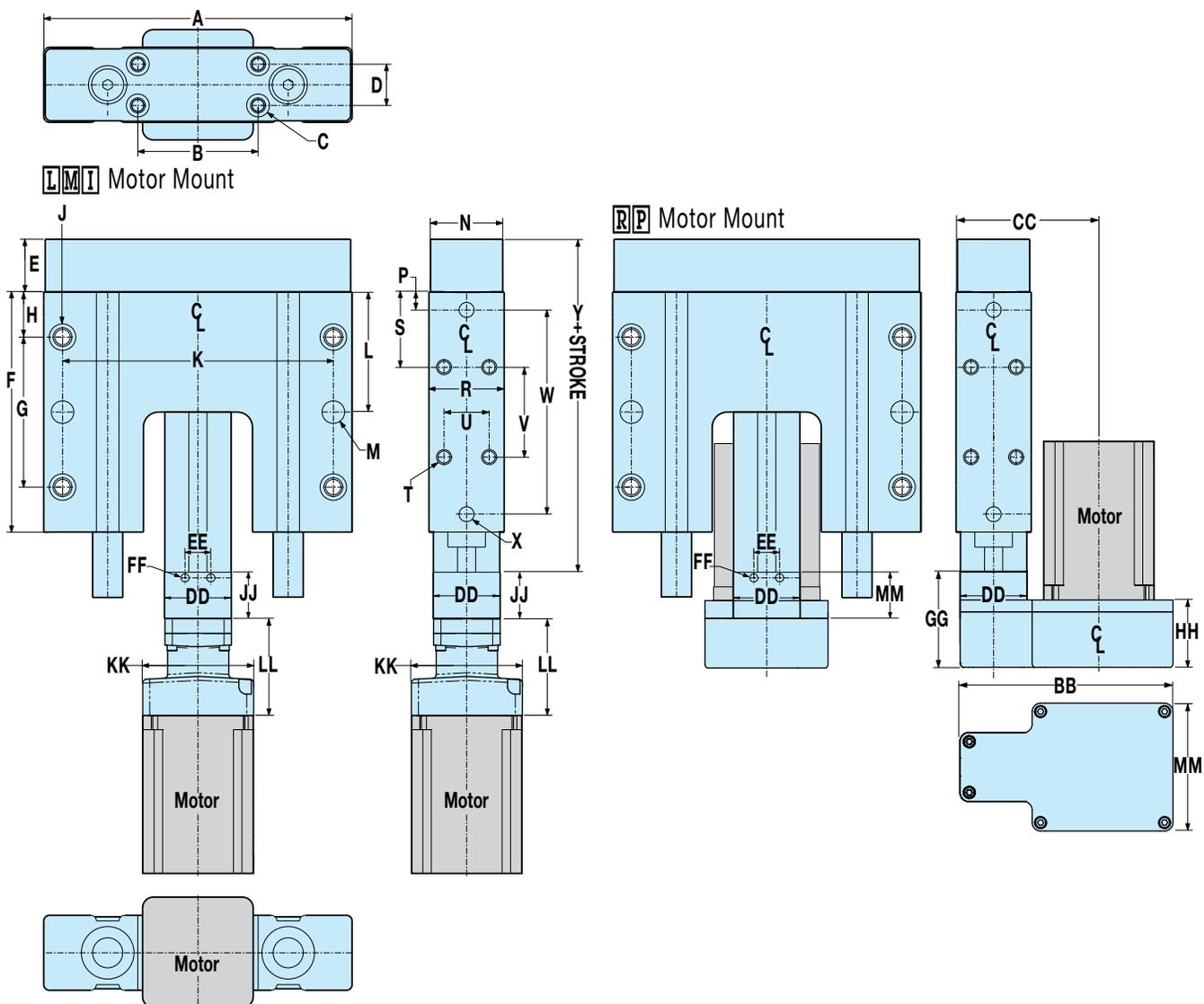

Size		A	B	C [4x]	D	E	F	G	H	J [4x]
12	in	5.13	2.000	1/4-20 \perp 0.38 \perp 0.22 OPP	0.688	0.88	4.00	2.500	0.750	\emptyset .266 Thru \perp 0.44 \perp 0.28 5/16-18 \perp 0.75 OPP
	mm	130.2	50.80	M6x1.0 \perp 09.5 \perp 5.6 OPP	17.46	22.4	101.6	63.50	19.05	\emptyset 6.76 Thru \perp 11.1 \perp 7.1 M8x1.25 \perp 19.1 OPP
16	in	6.25	2.500	5/16-18 \perp 0.44 \perp 0.28 OPP	1.000	1.13	5.00	2.625	1.188	\emptyset .266 Thru \perp 0.44 \perp 0.28 5/16-18 \perp 0.75 OPP
	mm	158.8	63.50	M8x1.25 \perp 11.1 \perp 7.1 OPP	25.40	28.6	127.0	66.68	30.18	\emptyset 6.76 Thru \perp 11.1 \perp 7.1 M8x1.25 \perp 19.1 OPP
24	in	7.75	3.500	5/16-18 \perp 0.44 \perp 0.28 OPP	1.375	1.38	6.00	3.875	1.063	\emptyset .328 Thru \perp 0.53 \perp 0.34 3/8-16 \perp 1.00 OPP
	mm	196.9	88.90	M8x1.25 \perp 11.1 \perp 7.1 OPP	34.93	35.1	152.4	98.43	27.00	\emptyset 8.33 Thru \perp 13.5 \perp 8.6 M10x1.5 \perp 25.4 OPP
32	in	10.00	5.000	3/8-16 \perp 0.53 \perp 0.50 OPP	1.750	1.63	7.00	4.125	1.438	\emptyset .453 Thru \perp 0.72 \perp 0.47 1/2-13 \perp 1.50 OPP
	mm	254.0	127.00	M10x1.5 \perp 13.5 \perp 12.7 OPP	44.45	41.4	177.8	104.78	36.51	\emptyset 10.49 Thru \perp 18.2 \perp 11.9 M12x1.75 \perp 38.1 OPP

GSA Guided Electric Rod-Style Actuator

SIZE: ALL

DIMENSIONS

tolomatic.com/CAD Download 3D CAD Always use CAD solid model to determine critical dimensions



Size		K	L	M Ø [2x]	N	P	R	S	T Ø [4x]	U	V	W	X Ø [4x]	Y
12	in	4.500	2.000	0.375 \downarrow 0.50	1.20	0.297	1.25	1.250	1/4-20 \downarrow 0.50	0.750	1.500	3.406	0.250 \downarrow 0.38	5.68
	mm	114.30	50.80	10.00 \downarrow 12.7	30.5	7.54	31.8	31.75	M6x1.0 \downarrow 12.7	19.05	38.10	86.51	6.00 \downarrow 9.5	144.1
16	in	5.438	2.500	0.375 \downarrow 0.50	1.70	0.516	1.75	1.625	1/4-20 \downarrow 0.50	1.000	1.750	3.969	0.250 \downarrow 0.38	6.42
	mm	138.13	63.50	10.00 \downarrow 12.7	43.2	13.11	44.5	41.28	M6x1.0 \downarrow 12.7	25.40	44.45	100.81	6.00 \downarrow 9.5	163.1
24	in	7.000	3.000	0.500 \downarrow 0.50	2.15	0.438	2.25	1.625	5/16-18 \downarrow 0.63	1.250	2.750	5.125	0.313 \downarrow 0.50	8.14
	mm	177.80	76.20	12.00 \downarrow 12.7	54.6	11.13	57.2	41.28	M8x1.25 \downarrow 16.0	31.75	69.85	130.18	8.00 \downarrow 9.5	206.6
32	in	9.000	3.500	0.500 \downarrow 0.50	2.65	0.594	2.75	2.125	3/8-16 \downarrow 0.75	1.750	2.750	5.812	0.375 \downarrow 0.50	9.81
	mm	228.60	88.90	12.00 \downarrow 12.7	67.3	15.09	69.9	53.98	M10x1.5 \downarrow 19.1	44.45	69.85	147.62	10.00 \downarrow 12.7	249.0

Size	Motor Frame	AA	BB ∞	CC ∞ 1:1	CC ∞ 2:1	DD	EE	FF [2x]	GG ∞	HH ∞	JJ	KK ∞	LL ∞	MM ∞	
12	17	in	1.34	3.92	2.63	NA	1.13	0.500	8-32 \downarrow 0.25	1.66	0.72	1.66	1.85	2.26	
		mm	34.1	99.5	66.9		28.6	12.70	M4x0.7 \downarrow 6.3	42.1	18.3	42.0	47.0	57.3	
	23	in	1.34	3.92	2.63		1.13	0.500	8-32 \downarrow 0.25	1.66	0.72	2.00	2.49	2.26	
		mm	34.1	99.5	66.9		28.6	12.70	M4x0.7 \downarrow 6.3	42.1	18.3	50.8	63.2	57.3	
16	23	in	1.34	4.04	2.88	1.38	0.500	8-32 \downarrow 0.25	1.66	0.72	2.25	2.49	2.26		
		mm	34.1	102.7	73.2	35.0	12.70	M4x0.7 \downarrow 6.3	42.1	18.3	57.2	63.2	57.3		
24	23	in	2.04	5.13	3.78	3.75	2.04	0.787	1/4-20 \downarrow 0.31	2.28	1.66	1.42	2.35	2.55	2.50
		mm	51.8	130.2	96.1	95.3	51.8	20.00	M6x1.0 \downarrow 8.6	57.9	42.2	36.0	59.7	64.8	63.5
	34	in	2.04	6.29	4.20	4.17	2.04	0.787	1/4-20 \downarrow 0.31	2.87	2.00	1.42	3.75	3.28	3.79
		mm	51.8	159.8	106.6	105.9	51.8	20.00	M6x1.0 \downarrow 8.6	72.8	50.7	36.0	95.3	83.3	96.3
32	23	in	2.58	5.89	4.26	4.28	2.58	0.950	5/16-18 \downarrow 0.50	3.19	2.00	1.79	3.00	2.63	2.58
		mm	65.5	149.6	108.3	108.9	65.5	24.13	M8x1.25 \downarrow 12.7	80.9	50.7	45.4	76.2	66.8	65.5
	34	in	2.58	7.52	5.11	5.08	2.58	0.950	5/16-18 \downarrow 0.50	3.19	2.00	1.79	3.75	2.38	4.25
		mm	65.5	190.9	129.9	129.0	65.5	24.13	M8x1.25 \downarrow 12.7	80.9	50.7	45.4	95.3	60.5	108.0



∞ NOTE: YM code may change this dimension. Always use configured CAD to determine critical dimensions



See dimensional drawing on previous page

CK & CKS STOP COLLARS



Provides a positive stop mechanism when required.

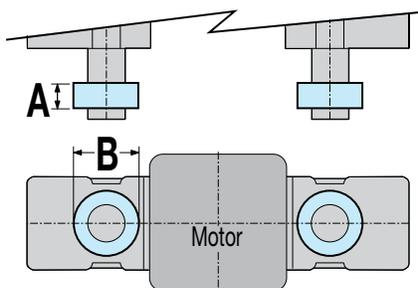

STANDARD GUIDE RODS

Size		A	B Ø
12	in	0.406	1.125
	mm	10.31	28.58
16	in	0.438	1.313
	mm	11.13	33.35
24	in	0.500	1.500
	mm	12.70	38.10
32	in	0.500	1.750
	mm	12.70	44.45

OVERSIZED GUIDE RODS

Size		A	B Ø
12	in	0.438	1.313
	mm	11.13	33.35
16	in	0.500	1.500
	mm	12.70	38.10
24	in	0.500	1.750
	mm	12.70	44.45
32	in	0.500	2.063
	mm	12.70	52.40



RSA & GSA products offer a wide range of sensing choices. There are 12 switch choices: reed, solid state PNP (sourcing) or solid state NPN (sinking); in normally open or normally closed; with flying leads or quick-disconnect.

Commonly used for end-of-stroke positioning, these switches allow installation anywhere along the entire actuator length. The internal magnet is a standard feature. Switches can be installed in the field at any time.

Switches are used to send digital signals to PLC (programmable logic controller), TTL, CMOS circuit or other controller device. Switches contain reverse polarity protection. Solid state QD cables are shielded; shield should be terminated at flying lead end.

All switches are CE rated and are RoHS compliant. Switches feature bright red or yellow LED signal indicators; solid state switches also have green LED power indicators.



	Order Code	Lead	Switching Logic	Power LED	Signal LED	Operating Voltage	**Power Rating (Watts)	Switching Current (mA max.)	Current Consumption	Voltage Drop	Leakage Current	Temp. Range	Shock / Vibration
REED	R Y	5m	SPST Normally Open	—	Red	5 - 240 AC/DC	**10.0	100mA	—	3.0 V max.	—	14 to 158°F [-10 to 70°C]	50 G / 9 G
	R K	QD*											
	N Y	5m	SPST Normally Closed	—	Yellow	5 - 110 AC/DC							
	N K	QD*											
SOLID STATE	T Y	5m	PNP (Sourcing) Normally Open	Green	Yellow	10 - 30 VDC	**3.0	100mA	20 mA @ 24V	2.0 V max.	0.05 mA max.		
	T K	QD*											
	K Y	5m	NPN (Sinking) Normally Open	Green	Red								
	K K	QD*											
	P Y	5m	PNP (Sourcing) Normally Closed	Green	Yellow								
	P K	QD*											
	H Y	5m	NPN (Sinking) Normally Closed	Green	Red								
	H K	QD*											

*QD = Quick-disconnect Enclosure classification IEC 529 IP67 (NEMA 6)

CABLES: Robotic grade, oil resistant polyurethane jacket, PVC insulation

⚠️ **WARNING: Do not exceed power rating (Watt = Voltage x Amperage). Permanent damage to sensor will occur.

SWITCH INSTALLATION



Place switch bracket into one of the four slots that run the length of the extruded tube. Note that there is a cutout on the actuator head (RSA) or tube (GSA) to allow insertion of the bracket. Insert the switch with the word "Tolomatic" facing up and slide it under the bracket. Position the bracket with the switch to the exact location desired, then lock them securely into place by tightening both set screws on the bracket.

RSA & GSA Electric Rod-Style Actuators

SWITCHES

WIRING DIAGRAMS

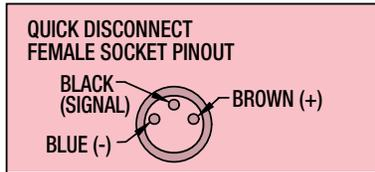
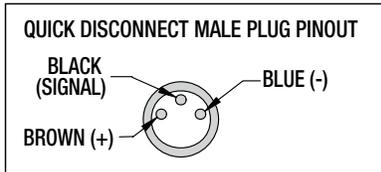
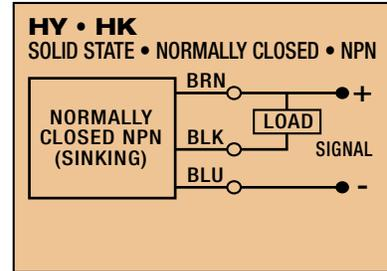
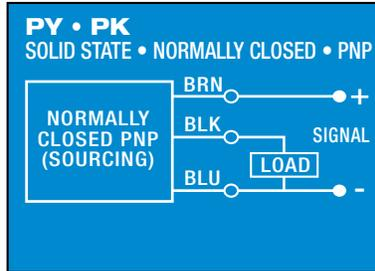
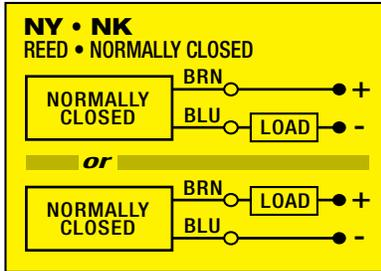
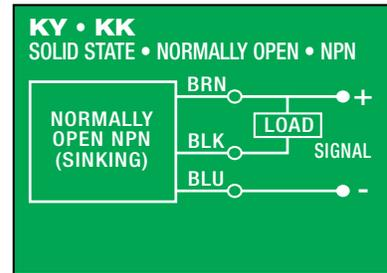
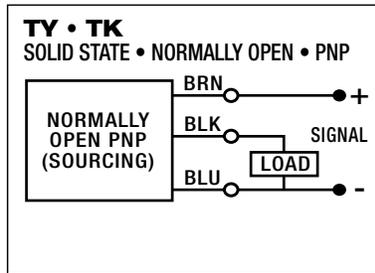
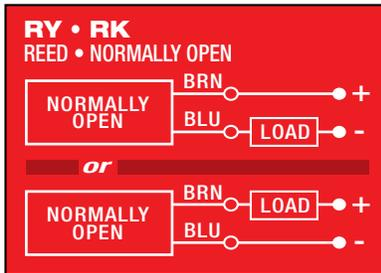

SWITCH DIMENSIONS

- direct connect

DETECTION POINT SOLID STATE

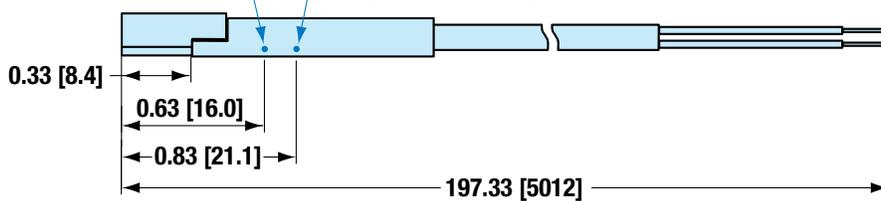

- QD (Quick-disconnect) switch

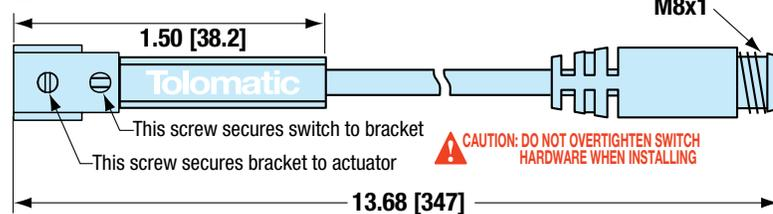

CAUTION: DO NOT OVERTIGHTEN SWITCH HARDWARE WHEN INSTALLING

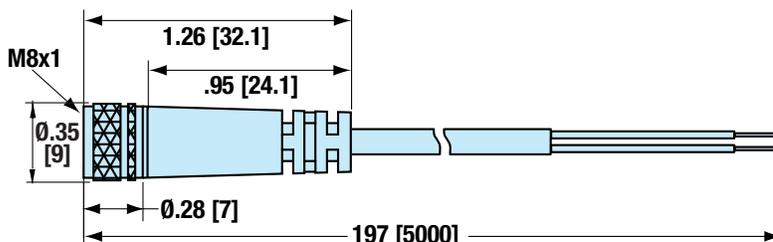

Dimensions shown in inches [dimensions in brackets millimeters]

MOUNTING DIMENSIONS

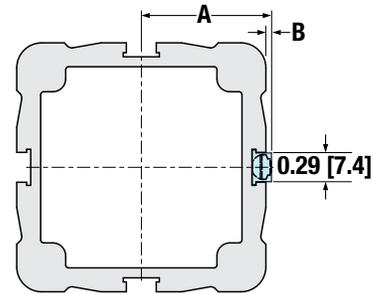

Size	A		B	
	in	mm	in	mm
12	0.68	17.2	0.13	3.3
16	0.77	19.6	0.11	2.9
24	1.06	26.9	0.06	1.5
32	1.31	33.2		
50	1.87	47.5		
64	2.31	58.6		

RSA & GSA Electric Rod-Style Actuators

Application Data Worksheet

USE THE TOLOMATIC SIZING AND SELECTION SOFTWARE AVAILABLE ON-LINE AT www.tolomatic.com or call Tolomatic at 1-800-328-2174. We will provide any assistance needed to determine the proper actuator for the job.

ACTUATOR ORIENTATION

- Horizontal
 Vertical-Motor End Up
 Angled
 Vertical-Motor End Down



Angle: _____ degrees

ACTUATOR REQUIREMENTS

- Stroke Length:** _____ inches millimeters
No. of Cycles: _____ per minute per hour
Actuator to Hold Position: required not required
If Hold Required: after move during power loss
Motor: Third Party Motor Tolomatic Motor

APPLICATION ENVIRONMENT

- Ambient Temperature:** _____ °F °C
 Actuator Environment Description and Ingress Protection Requirements:

MOTION & FORCES

Extend

- Move Distance: _____ in mm
 Move Time: _____ seconds
 Max. Speed: _____ in/s mm/s
 Dwell Time After Move: _____ seconds

Load

- Load:** _____ lb kg
Supported by Actuator: _____ %
Moment Prevention: Guided/Supported
Center of Load:
 D_x: _____ in mm
 D_y: _____ in mm
 D_z: _____ in mm
Assign to Moves: Extend Retract

Retract

- Move Distance: _____ in mm
 Move Time: _____ seconds
 Max. Speed: _____ in/s mm/s
 Dwell Time After Move: _____ seconds

Force

- Force:** _____ lb_f N
Force Direction: Toward Away
Direction of Applied Force: F_x F_y F_z
Center of Applied Force:
 D_x: _____ in mm
 D_y: _____ in mm
 D_z: _____ in mm
Assign to Moves: Extend Retract

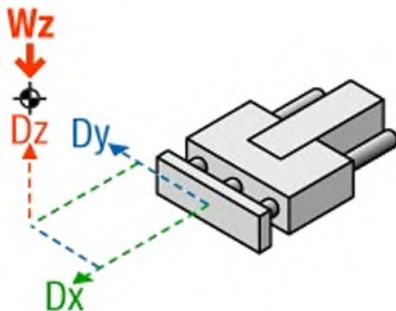

tolomatic.com/ask
 Technical support
 before and after
 purchase

sizeit.tolomatic.com
 for fast, accurate
 actuator selection

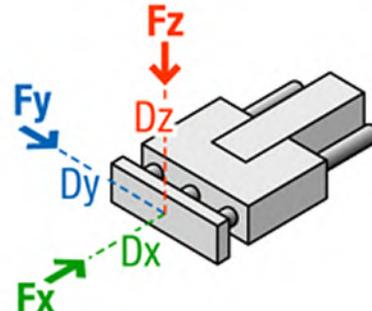

RSA & GSA Electric Rod-Style Actuators

Selection Guidelines

1 ESTABLISH MOTION PROFILE

Using the application stroke length, desired cycle time, loads and forces, establish the motion profile details including linear velocity and thrust in each of its segments.

2 SELECT ACTUATOR TYPE

If side (radial) loads are present, select GSA.

3 SELECT ACTUATOR SIZE AND SCREW TYPE

Based on the required velocities and thrust select an actuator size and type and lead of screw drive.

4 VERIFY CRITICAL SPEED OF THE SCREW

Verify that the application's peak linear velocity does not exceed the critical speed value for the size and lead of the screw selected.

5 VERIFY AXIAL BUCKLING STRENGTH OF THE SCREW

Verify that the peak thrust does not exceed the critical buckling force for the size of the screw selected.

6 COMPARE APPLICATION'S PEAK PARAMETERS TO PEAK CAPACITY (PEAK REGION) OF SELECTED ACTUATOR (ROLLER SCREW)

When a roller screw is selected, calculate the application's required peak thrust and peak velocity and compare to the graphs. The selection must satisfy the application's peak requirements.

7 CALCULATE LUBRICATION INTERVAL (ROLLER SCREW)

When a roller screw is selected, calculate the recommended lubrication interval. See page R/GSA_33 and parts sheets for complete lubrication information for the RSA24, RSA32, RSA50 and RSA64 HT option.



The above guidelines are for reference only. Use Tolomatic online sizing software for best results.

8 TEMPERATURE CONSIDERATIONS

If the application's ambient temperature lies outside of the allowed range [roller screw: 50° to 122°F (10° to 50°C), all others 40° to 130°F (4° to 54°C)], contact the factory. Note that in aggressive applications where roller screw is used, outside temperature of the actuator's body can approach 180°F (82°C), and adequate clearance to avoid overheating of other system components should be allowed.

9 ESTABLISH TOTAL TORQUE REQUIREMENTS

Calculate total system inertia, the peak and the RMS torque required from the motor to overcome internal friction, external forces and accelerate/decelerate the load.

10 SELECT A MOTOR AND A CONTROLLER

Use the obtained total torque value to select a motor and a reduction device (if required). Verify that the peak torque value is below the motor's peak torque curve, and that the continuous torque value is below the motor's continuous torque curve. Verify the minimum torque margin (15%). Verify the inertia match. Select a controller.

11 SELECT A MOTOR-ACTUATOR CONFIGURATION AND SENSORS IF REQUIRED

Select an inline or a reverse-parallel motor configuration. Select mounting and rod end options. Select position sensors (if required). 12 sensor choices include: reed, solid state PNP or NPN, all in normally open or normally closed, with flying leads or quick-disconnect couplers.

12 SELECT ROD END OPTIONS AND MOUNTING OPTIONS

Rod end options include: CLV clevis rod end, SRE spherical rod end, MET externally threaded rod end, ALC alignment coupler, XR rod extension. Mounting options include: TRN trunnion mount, FFG front flange mount, MP2 mounting plates, PCD clevis mount, PCS eye mount, BFG back flange mount.

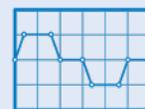

sizeit.tolomatic.com
for fast, accurate
actuator selection



tolomatic.com/ask
Technical support
before and after
purchase

RSA & GSA Electric Rod-Style Actuators

SERVICE PARTS ORDERING

RSA ACTUATOR MOUNTING REPLACEMENT KITS

Code	Size	12		16		24		32		50		64ST		64HT	
		Description	U.S.	Metric	U.S.	Metric	U.S.	Metric	U.S.	Metric	U.S.	Metric	U.S.	Metric	U.S.
For all motor mounts															
FFG	Front Flange Mount	1107-9013	2107-9013	1112-9013	2112-9013	1124-9022	2124-9032	1132-9022	2132-9042	1150-9022	2150-9042	1164-9022	2164-9022	1164-9484	2164-9022
MP2	Mounting Plate	1107-9015	2107-9015	1112-9014	2112-9014	1124-9023	2124-9033	1132-9023	2132-9043	1150-9023	2150-9043	1164-9023	2164-9023	1164-9375	2164-9375
		1112-9014*	2112-9014*	*Mounting Plate with 23 frame motor or YMH Option (for RSA12 size only)											
For RP motor mounting only															
BFG	Back Flange Mount	1107-9014	2107-9014	1112-9025	2112-9025	1124-9022	2124-9032	1132-9022	2132-9042	1150-9022	2150-9042	1164-9022	2164-9022	1164-9484	2164-9022
PCS	Eye Mount	1107-9016	2107-9016	1107-9016	2107-9016	1124-9024	2124-9034	1132-9024	2132-9044	1150-9024	2150-9044	1164-9024	2164-9024	1164-9344	2164-9344
PCD	Clevis Mount	1107-9017	2107-9017	1107-9017	2107-9017	1124-9025	2124-9035	1132-9025	2132-9045	1150-9025	2150-9045	1164-9025	2164-9025	1164-9345	2164-9345

RSA ROD END REPLACEMENT KITS

U.S. MODELS

Code	Size	12	16	24ST	24HT	32ST	32HT	50ST	50HT	64ST	64HT
CLV	Clevis End	1107-9021	1112-9020	1124-9029	1124-9396	1124-9029	1124-9396	1150-9029	1150-9396	1150-9029	1164-9386
SRE	Spherical Rod Eye	1107-9020	1112-9019	1124-9028	1124-9397	1124-9028	1124-9397	1150-9028	1150-9397	1150-9028	1164-9028
MET	External Threaded	1107-1073	1112-1058	1124-1057	1124-1815	1124-1057	1124-1815	1150-1057	1150-1815	1150-1057	1164-1035
ALC*	Alignment Coupler	1107-1076	1112-1061	1124-9004	1124-9004	1124-9004	1124-9004	1150-9009	1150-9009	1150-9009	1164-9385

METRIC MODELS

Code	Size	12	16	24ST	24HT	32ST	32HT	50ST	50HT	64ST	64HT
CLV	Clevis End	2107-9021	2112-9020	2124-9039	2124-9396	2132-9049	2132-9396	2150-9049	2150-9396	2164-9029	2164-9386
SRE	Spherical Rod Eye	2107-9020	2112-9019	2124-9038	2124-9397	2132-9048	2132-9397	2150-9048	2150-9397	2164-9028	2164-9387
MET	External Threaded	2107-1073	2112-1058	2124-1067	2124-1815	2132-1057	2132-1815	2150-1057	2150-1815	2164-1057	2164-1546
ALC*	Alignment Coupler	NA	NA	2124-1070	2132-1060	2132-1060	2132-1060	2150-1060	2150-1060	2164-1060	2164-1060

*NOTE: Alignment coupler is internally threaded, if external thread is desired order MET also

NA = Not Available

GSA OPTIONS REPLACEMENT KITS

Description	SIZE			
	12	16	24	32
Stop Collar	2312-1005	2317-1005	2334-1005	2332-1005
Stainless Steel Stop Collar	2312-1056	2317-1056	2324-1056	2332-1056

Description	SIZE			
	12	16	24	32
Over-Sized Stop Collar	2317-1005	2324-1005	2332-1005	2348-1005
Stainless Steel Over-Sized Stop Collar	2317-1056	2324-1056	2332-1056	2348-1056

Kits include one collar and required fasteners

RSA & GSA SWITCHES

To order switch kit use configuration code for switch preceded by SW and actuator code.

EXAMPLE: **SWR|SA|24|KK**



The example is for Solid State NPN, Normally Open Switch with Quick-disconnect couplers. Each switch kit is complete with Bracket, Set Screw, Switch and mating QD cable. Note that the bracket/switch size is common and may be used on any size RSA.

NOTE: Refer to parts sheets to replace switches on actuators manufactured before 5-10-2010.

Code	Lead	Normally	Sensor Type
R Y	5m (197 in)	Open	Reed
R K	Quick-disconnect		
N Y	5m (197 in)	Closed	Reed
N K	Quick-disconnect		
T Y	5m (197 in)	Open	Solid State PNP
T K	Quick-disconnect		
K Y	5m (197 in)	Open	Solid State NPN
K K	Quick-disconnect		
P Y	5m (197 in)	Closed	Solid State PNP
P K	Quick-disconnect		
H Y	5m (197 in)	Closed	Solid State NPN
H K	Quick-disconnect		

RSA Reverse-Parallel Tensioning Tool Kit	24ST	24HT / 32 all	50 all & 64 all
order by part number	1124-9430	1132-9430	1150-9430

RSA ST & HT Electric Rod-Style Actuator

ORDERING

ACTUATOR RSA 50 BNL02 SK35 RPL ST1 FFG XR6 ALC MET KK2 YM **OPTIONS**

MODEL & MOUNTING

RSA Rod-Style Screw-Drive Actuator

SIZE

12, 16, 24, 32, 50, 64

NUT/SCREW

SIZE	CODE	CODE NUMBER
12	SN	01,02,05
	BZ	10
	BN, BNL	08
16	SN	01,02,05
	BZ	10
	BN, BNL	08
24	SN	02,04,08
	BZ	10
	BN, BNL	02,05
	BNM	05,10
	RN	04,05,10
32	BZ	10
	BN, BNL	02,05
	BNM	05,10,20
	RN	04,05,10
50	BZ	10
	BN, BNL	01,02,04
	BNM	05,10,25
	RN	05,10
64	BZ	10
	BN, BNL	02,04,53
	BNM	05,10,20
	BNH	02
	RN	05,10

STROKE LENGTH

SK ___ Enter desired stroke length in decimal inches

SM† ___ (Metric Mounting)
Enter desired stroke length in millimeters

† The metric version provides metric tapped rod end, actuator mounting and dowel pins

NOTE: Actuator mounting threads and mounting fasteners will be either inch or metric; depending on how stroke length is indicated SK=inch mounting

SM= metric mounting

MAXIMUM STROKE

SIZE	BN, BZ, SN		RN	
	in	mm	in	mm
12	12	304.8	12	304.8
16	18	457.2	18	457.2
24	24	609.6	24	609.6
32	36	914.4	36	914.4
50	48	1,219.2	36 ^S	914.4 ^S
64	60	1,524.0	36 ^S	914.4 ^S

MOTOR MOUNTING

LMI	In-line motor mount
RP1	1:1 ratio, reverse parallel motor mount
RPL1	1:1 ratio, reverse parallel motor mount, left or right see page 18 for details
RPR1	1:1 ratio, reverse parallel motor mount, left or right see page 18 for details
RP2	2:1 ratio, reverse parallel motor mount
RPL2	2:1 ratio, reverse parallel motor mount, left or right see page 18 for details
RPR2	2:1 ratio, reverse parallel motor mount, left or right see page 18 for details

⊗ RP2 not available on 12 or 16 size

RP BELT TENSIONING

TEN Belt tensioning tool for RP motor mounting

STANDARD OR HIGH TORQUE

ST1 Standard RS Actuator
HT* High Torque Option
*requires keyed motor

⊗ HT not available on 12 or 16 size
NOTE: RN always requires HT option

TRUNNION MOUNT

TRR Trunnion mount
⊗ Not available on 12 or 16 size with LMI motor mount
NOTE: Trunnion mount is not available for field retrofit, contact Tolomatic for details

ACTUATOR MOUNTING

For all motor mounts:
FFG Front Flange Mount
FFGR Front Flange Mount rotated 90° (see pg. 22)
MP2 Mounting Plates (2 required)
For RP motor mounting only:
PCD Clevis Mount
PCDR Clevis Mount rotated 90° (see pg. 25)
PCS Eye Mount
PCSR Eye Mount rotated 90° (see pg. 25)
BFG Back Flange Mount

^S RSA50 & RSA64 extended stroke length 48" (1219 mm) available for roller screws, contact Tolomatic for production time

ROD EXTENSION

XR ___ Enter desired rod extension in inches (SK) or millimeters (SM)

(Same unit of measure as stroke length is required)

▲ For vertical applications only.

NOTE: The XR extension + stroke should not exceed the max. stroke of the specified actuator. (See MAX. STROKE table) Consult Tolomatic for extensions greater than the max. stroke length.

ROD END

Internally threaded rod end is standard
CLV Clevis Rod End
SRE Spherical Rod End
MET Externally Threaded Rod End
ALC Alignment Coupler Rod End*
Z12 Grease Zerk at 12 O'clock position (see page 43)

*NOTE: Alignment coupler is internally threaded, if external thread is desired order MET also

ENVIRONMENTAL PROTECTION

Standard actuator IP54
IP67 Basic ingress protection (RSA32, 50, 64 only)
LUB Grease, Food/Drug

SWITCHES

TYPE	LOGIC	NORMALLY	QUICK-DISCONNECT	CODE	QUANTITY	LEAD LENGTH
REED	SPST	Open	no	RY	After code enter quantity desired	5 meters (16.4 feet)
		Closed	yes	RK		
SOLID STATE	PNP	Open	no	TY		
		Closed	yes	TK		
	NPN	Open	no	KY		
		Closed	yes	KK		
PNP	Closed	no	PY			
	Closed	yes	PK			
NPN	Closed	no	HY			
	Closed	yes	HK			

Not all codes listed are compatible with all options. Contact Tolomatic with any questions.

YOUR MOTOR HERE

YM _____ Motor mount for non-Tolomatic motor. www.tolomatic.com

Brakes mounted on reverse parallel motor mounts (especially in vertically positioned actuators) will not prevent back driving of the screw and the load falling under gravity in the event of a timing belt failure. An inline motor mount with a fail-safe brake mounted directly to the actuator shaft or a special geared or thru-shaft reverse parallel construction should be considered if a brake is required in a safety critical application. Contact Tolomatic for alternate reverse parallel brake mounting options.

Gearheads may be used with RSA ST or GSA ST reverse parallel motor mounts. However, the torque on the belt and internal ST RP components must remain below the capabilities of the assembly to prevent belt slipping or premature failure. Contact Tolomatic for additional information if required.

GSA Guided Electric Rod-Style Actuator

ORDERING

ACTUATOR GSA 24 BN02 SK23 **OPTIONS** RP1 CBSO CKS KK2 YM

MODEL & MOUNTING
GSA Guided Screw-Drive Actuator

SIZE
12, 16, 24, 32

NUT/SCREW COMBINATIONS

SIZE	CODE	CODE NUMBER
12	SN	01,02,05
	BZ	10
	BN, BNL	08
16	SN	01,02,05
	BZ	10
	BN, BNL	08
24	BZ	10
	BN, BNL	02,05
32	BZ	10
	BN, BNL	02,05
	BNM	20

STROKE LENGTH

SK ___ Enter desired stroke length in decimal inches

SM † ___ (Metric Mounting) Enter desired stroke length in millimeters

NOTE: Actuator mounting threads and mounting fasteners will be either inch or metric; depending on how stroke length is indicated **SK**=inch mounting
SM= metric mounting

SIZE	MAXIMUM STROKE	
	GSA	
	in	mm
12	18	457.2
16	24	609.6
24	30	762.0
32	36	914.4

† The metric version provides metric tapped tooling plate, actuator mounting and dowel pins

MOTOR MOUNTING

LMI In-line motor mount
RP1 1:1 ratio, reverse parallel motor mount
RP2 2:1 ratio, reverse parallel motor mount
✗ RP2 not available on 12 or 16 size

BEARINGS & GUIDE RODS (GSA ONLY)

LB Linear Bearings*
CB Composite Bearings, Standard Size Rods
COB Composite Bearings, Over Sized Rods
CBS Composite Bearings, Standard Size Stainless Steel Rods
CBSO Composite Bearings, Over-Sized Stainless Steel Rods
✗ *Stainless steel guide rods not available with Linear Bearings

STOP COLLAR (GSA ONLY)

CK Steel Stop Collar
CKS Stainless Steel Stop Collar
NOTE: The correct Stop Collar will be automatically chosen based on the bearing and guide rod previously selected.

Not all codes listed are compatible with all options. Contact Tolomatic with any questions.



SWITCHES

TYPE	LOGIC	NORMALLY	QUICK-DISCONNECT	CODE	QUANTITY	LEAD LENGTH
REED	SPST	Open	no	RY	After code enter quantity desired	5 meters (16.4 feet)
		Open	yes	RK		
SOLID STATE	PNP	Closed	no	NY		
		Closed	yes	NK		
SOLID STATE	NPN	Open	no	TY		
		Open	yes	TK		
SOLID STATE	PNP	Closed	no	KY		
		Closed	yes	PK		
SOLID STATE	NPN	Closed	no	HY		
		Closed	yes	HK		

YOUR MOTOR HERE

YM _____ Motor mount for non-Tolomatic motor.
www.tolomatic.com

Brakes mounted on reverse parallel motor mounts (especially in vertically positioned actuators) will not prevent back driving of the screw and the load falling under gravity in the event of a timing belt failure. An inline motor mount with a fail-safe brake mounted directly to the actuator shaft or a special geared or thru-shaft reverse parallel construction should be considered if a brake is required in a safety critical application. Contact Tolomatic for alternate reverse parallel brake mounting options.

Gearheads may be used with RSA ST or GSA ST reverse parallel motor mounts. However, the torque on the belt and internal ST RP components must remain below the capabilities of the assembly to prevent belt slipping or premature failure. Contact Tolomatic for additional information if required.

FOOD GRADE LUBRICATION

LUB Grease, Food/Drug

RSA-ST

RSA-HT

GSA

The Tolomatic Difference Expect More From the Industry Leader:



INNOVATIVE PRODUCTS

Solutions with Endurance TechnologySM for challenging applications.



FAST DELIVERY

Built-to-order with configurable stroke lengths and flexible mounting options.

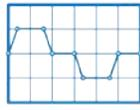

ACTUATOR SIZING

Size and select electric actuators with our online software.



YOUR MOTOR HERE[®]

Match your motor to compatible mounting plates with Tolomatic actuators.



CAD LIBRARY

Download 2D or 3D CAD files for Tolomatic products.



TECHNICAL SUPPORT

Get a question answered or request a virtual design consultation with one of our engineers.

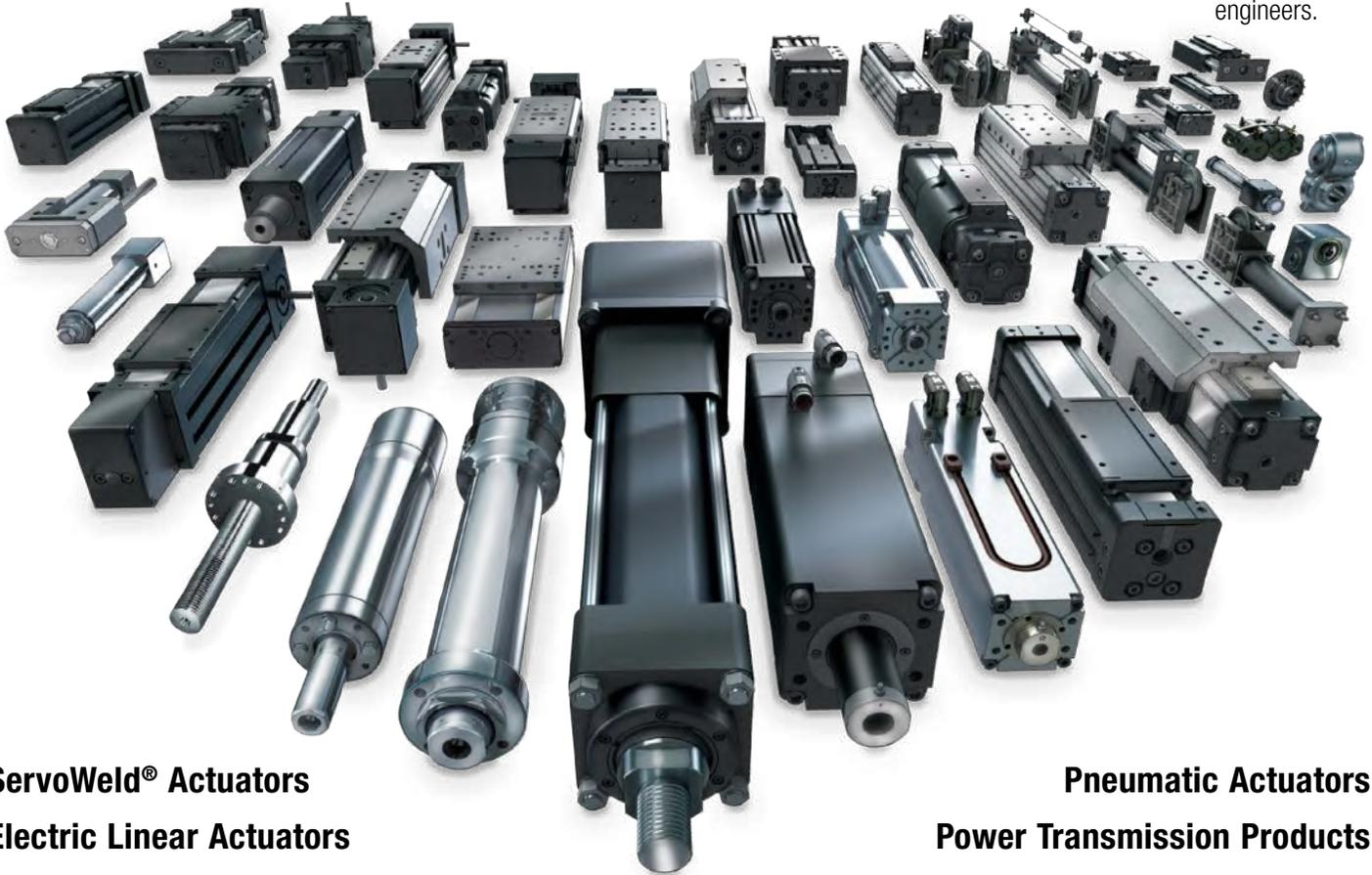

ServoWeld[®] Actuators
Electric Linear Actuators

Pneumatic Actuators
Power Transmission Products



MADE IN U.S.A.

Tolomatic[™]
EXCELLENCE IN MOTION

COMPANY WITH
QUALITY SYSTEM
CERTIFIED BY DNV
= ISO 9001 =
Certified site: Hamel, MN

USA - Headquarters

Tolomatic Inc.
3800 County Road 116
Hamel, MN 55340, USA
Phone: (763) 478-8000
Toll-Free: **1-800-328-2174**
sales@tolomatic.com
www.tolomatic.com

MEXICO

Centro de Servicio
Parque Tecnológico Innovación
Int. 23, Lateral Estatal 431,
Santiago de Querétaro,
El Marqués, México, C.P. 76246
Phone: +1 (763) 478-8000
help@tolomatic.com

EUROPE

Tolomatic Europe GmbH
Elisabethenstr. 20
65428 Rüsselsheim
Germany
Phone: +49 6142 17604-0
help@tolomatic.eu
www.tolomatic.com/de-de

CHINA

Tolomatic Automation Products (Suzhou) Co. Ltd.
No. 60 Chuangye Street, Building 2
Huqiu District, SND Suzhou
Jiangsu 215011 - P.R. China
Phone: +86 (512) 6750-8506
Tolomatic_China@tolomatic.com

All brand and product names are trademarks or registered trademarks of their respective owners. Information in this document is believed accurate at time of printing. However, Tolomatic assumes no responsibility for its use or for any errors

that may appear in this document. Tolomatic reserves the right to change the design or operation of the equipment described herein and any associated motion products without notice. Information in this document is subject to change without notice.

Visit www.tolomatic.com for the most up-to-date technical information